

1997



Campagnolo

Campagnolo



In this end-of-the-century of enormous change, on a planet which is increasingly technological and multi-media base, Man re-discovers that ancestral need to be at one with Nature, perhaps through a sport such as cycling.

For more than 60 years, CAMPAGNOLO has been striving to bring within the reach of all cyclists, established champions and ordinary enthusiasts alike, products of the highest functional performance and reliability.

With the new range introduced in this brochure, yet another step forward has been made in enabling everyone to exploit ever-more advanced design and production technologies, aimed at creating bicycle components of the highest level.

Groupsets with the latest 9-speed transmissions, the ever-increasing use of sophisticated materials such as titanium, increased lightness - these are just some of the many, important innovations you are invited to discover in the new 1997 range of products.

Products which have been conceived and produced with the same philosophy which, since its very beginning, has inspired and driven the work of CAMPAGNOLO, allowing everyone to cycle in an ever-safer and more comfortable way.

Today more than ever before, CAMPAGNOLO, launched towards the third millennium, heralds the cycling of the future.

GROUPS

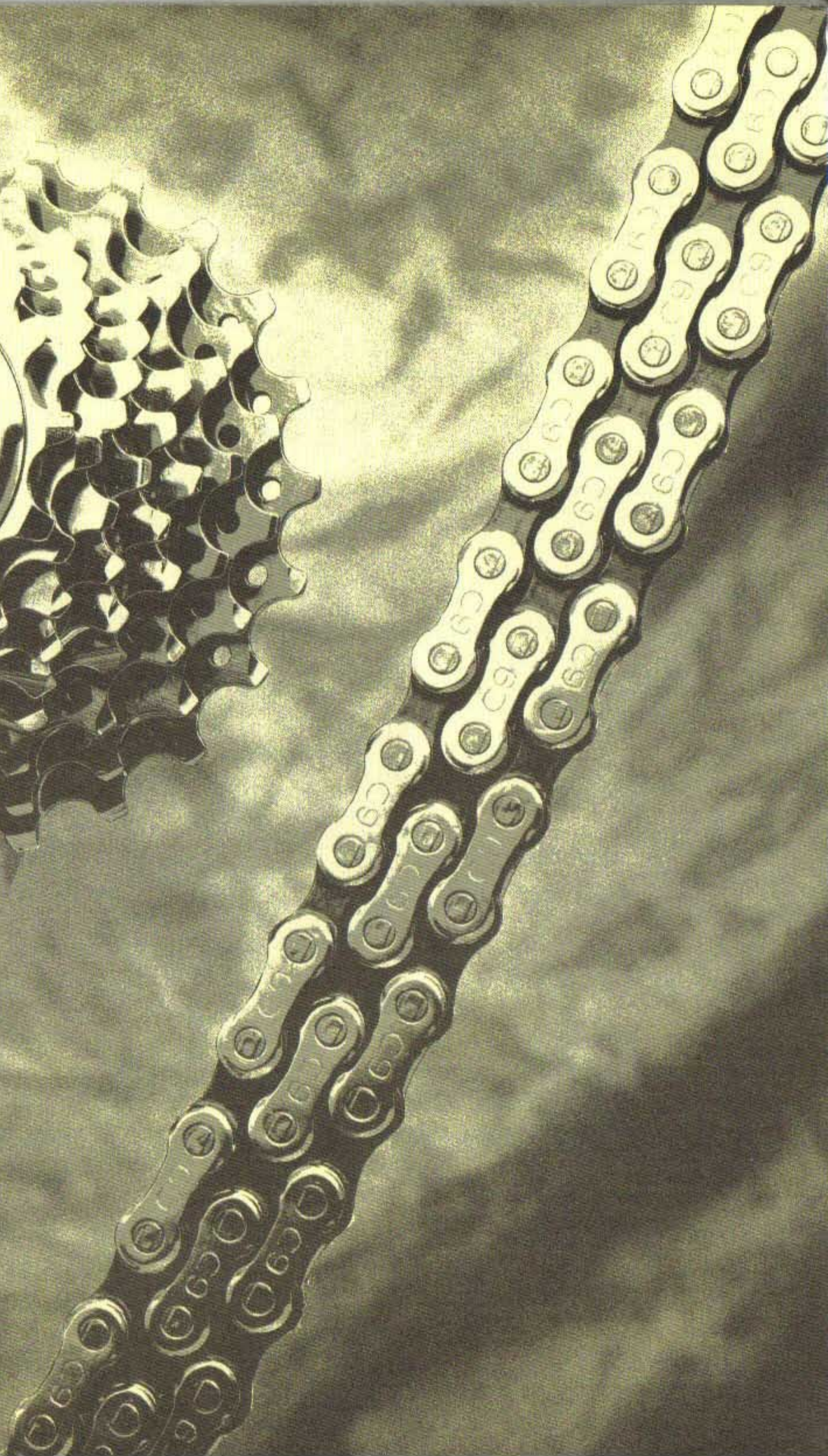
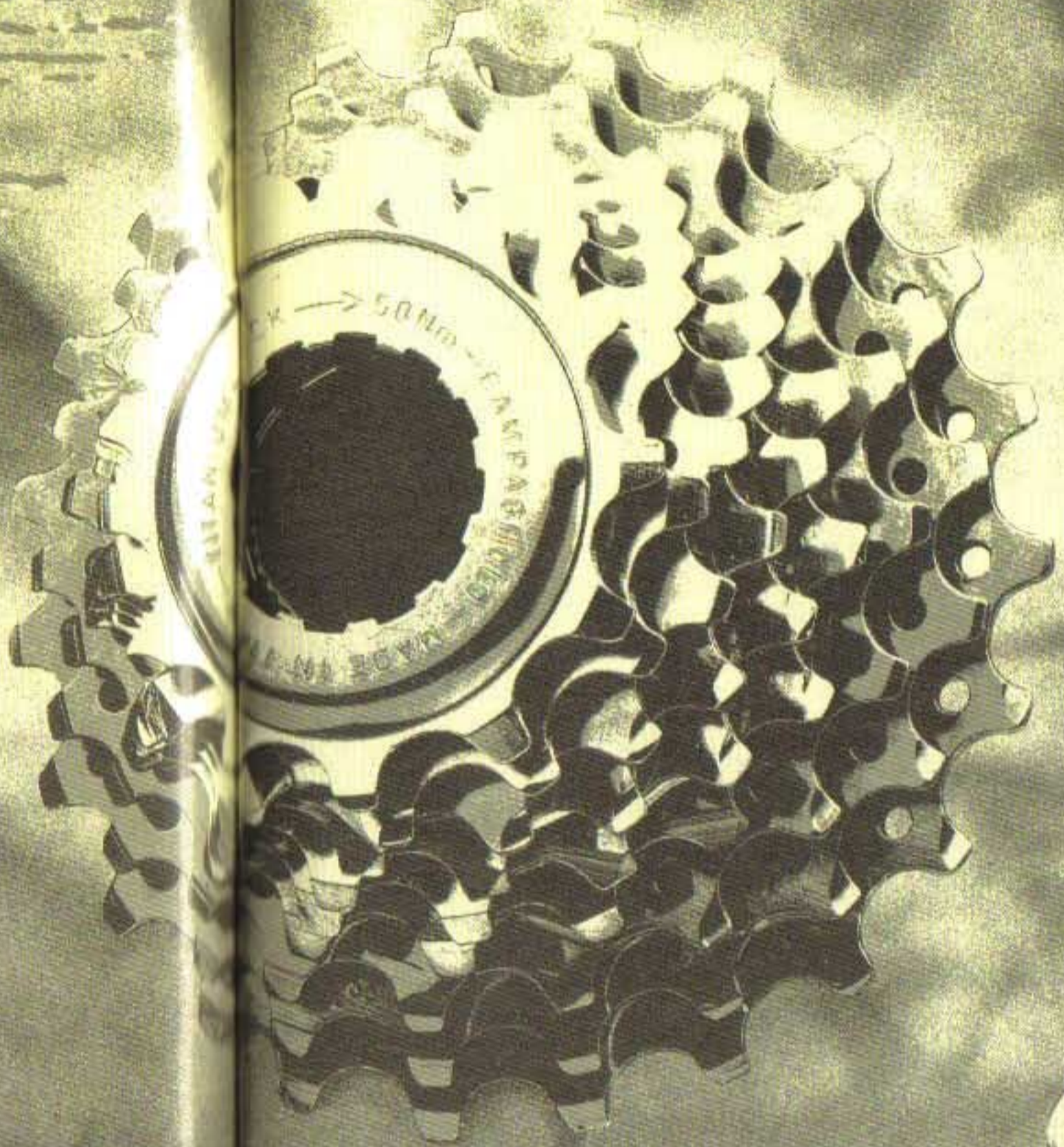

GROUPS

GROUP-SETS

For more than 60 years, CAMPAGNOLO has been alongside the great champions, elite amateurs or club riders. Right from the beginning, the main objective has always been to design, produce and make available to all the best products possible, in terms of functionality, performance and comfort.

The 1997 range is a further step towards the year 2000, by virtue of the introduction of new products and concepts, including the new EXA-drive transmission with its 9-speed freewheel cassette and a further, notable reduction in weight.

9-SPEED FREEWHEEL CASSETTE

In order to produce an 18-speed transmission, new components have been conceived and developed, including a brand-new 9-speed cassette freewheel, based on the proven EXA-DRIVE system.

All the original functional characteristics of CAMPAGNOLO groupsets have been maintained and even improved, thus guaranteeing perfect, indexed gear-changing in any situation.

The tooth profile has been further refined and is perfectly integrated with the new chain, ensuring even faster and more

precise gear-changing.

The new 9-speed cassettes, built with an entirely innovative inner body which renders them even lighter than before, are available in both steel and titanium versions, each having the same tooth profile and identical level of performance.

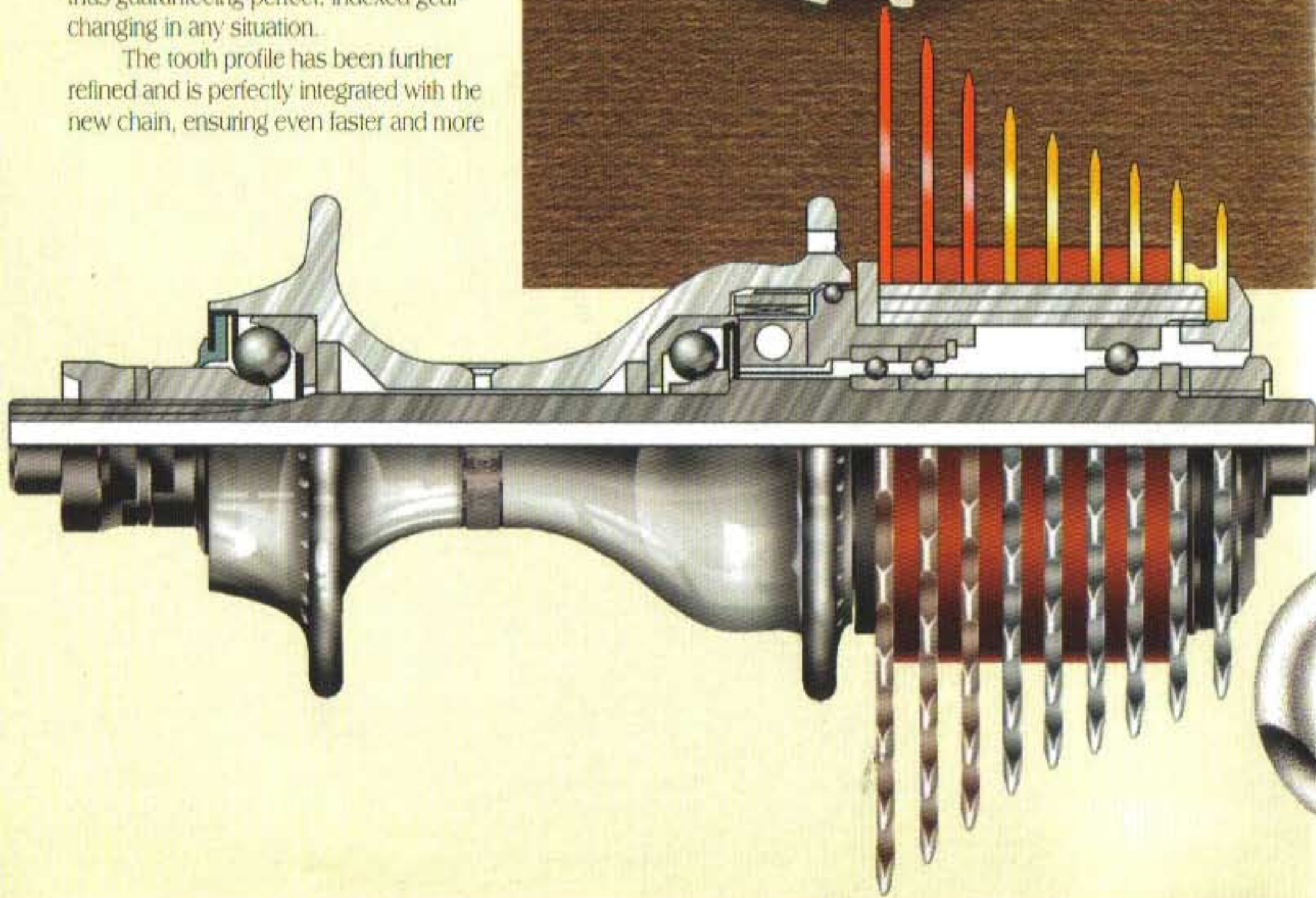
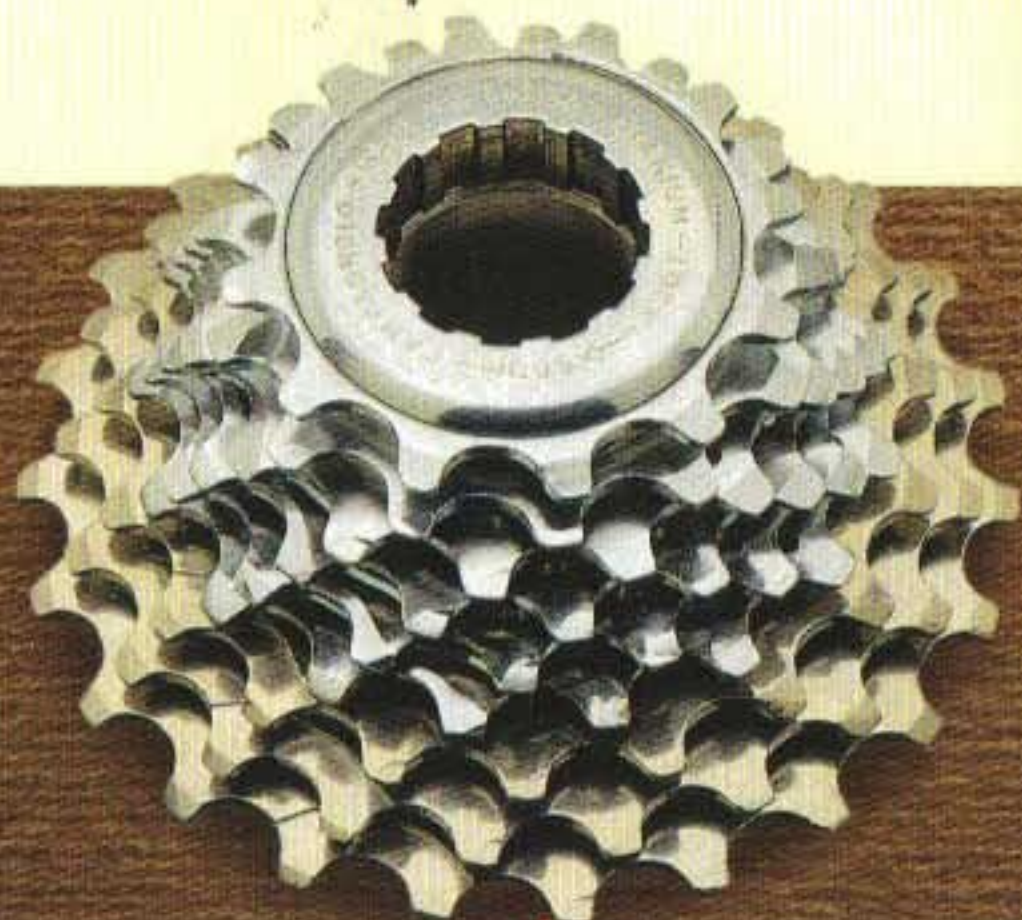

9-SPEED CHAIN

The chain is obviously an essential component of the new 9-speed set-up.

In effect, the design of the new transmission called for the reduction in width of both sprockets and spacers in order to obtain an overall freewheel width equal to that of the classic 8-speed system.

For the first time in this sector, CAMPAGNOLO has developed an innovative chain specifically designed to be used with 9-speed freewheels.

Thanks to the exclusive FLOATING-LINK SYSTEM (patent pending) during gear-changing, whether going up or down the freewheel, the chain is now much closer to the next sprocket, which permits a reduction in

spacing and which renders the gear-change faster and more precise.

The special chamfers on the external chain plates allow a perfect and silent meshing with the jockey-wheels of the rear

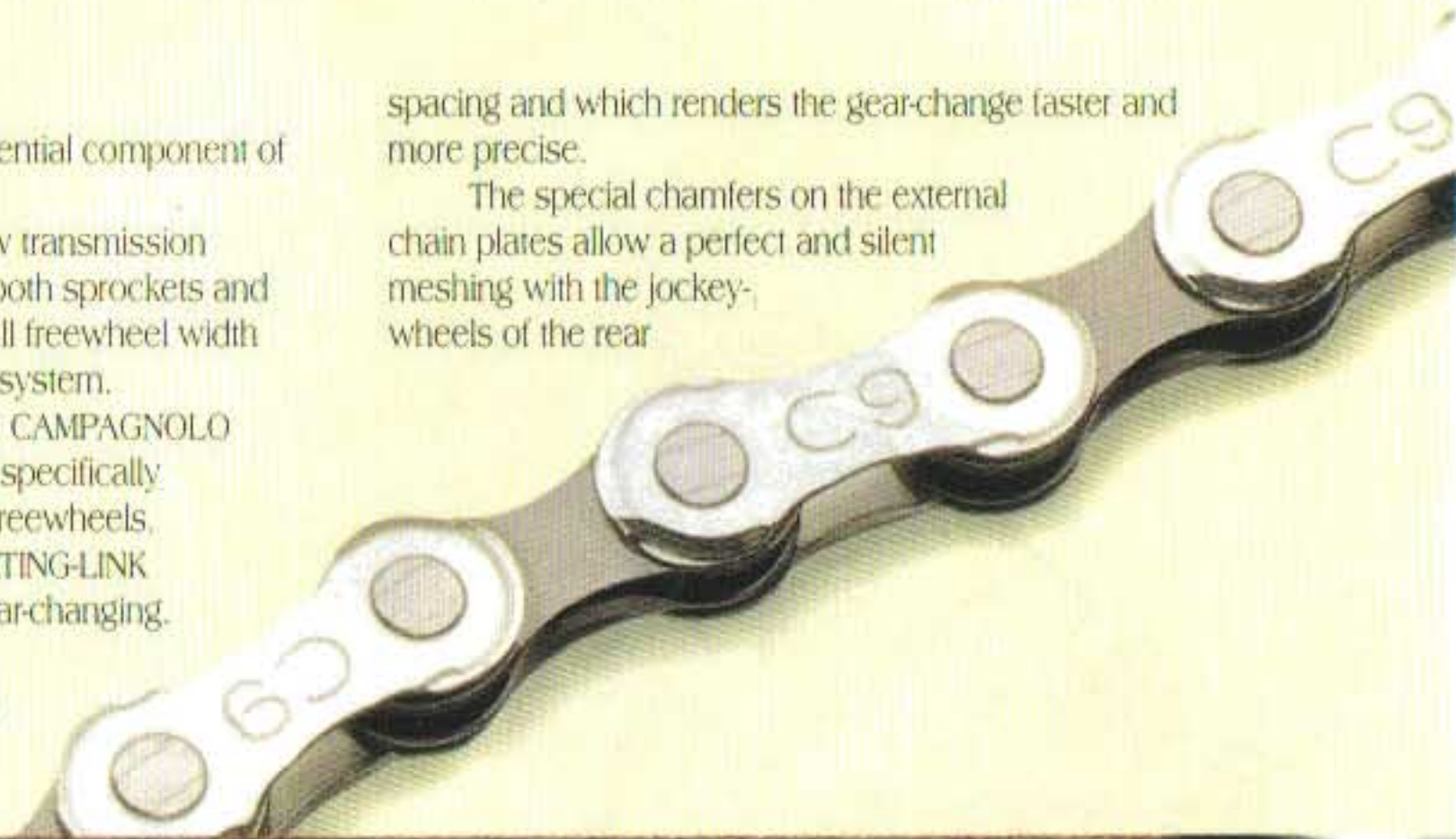

9 Speed



mechanism, even at maximum chain angulation; in addition, the nickel-teflon finish of the plates notably reduces friction with the links and pins, making the chain extremely quiet and long-lasting.

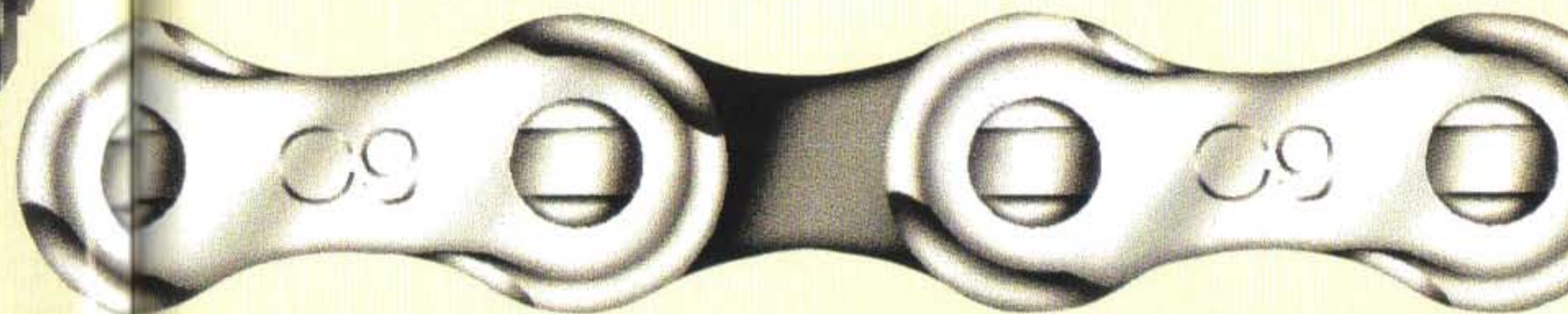



9-SPEED REAR MECHANISMS

The RECORD and CHORUS rear mechanisms have been modified to increase the range of travel to accommodate a 9-speed gear cluster, as well as to allow their use with the new 9-speed chain. New, narrower jockey-wheels with a revised profile, perfectly matched to the links of the 9-speed chain, ensure maximum quietness of operation, even in conditions of extreme chain angulation.

The design of the new cage of the rear mechanism makes it possible to position it at an even greater distance from the wheel spokes, thus eliminating all chance of accidental contact.

9-SPEED ERGOPOWER

In addition to the re-design of the RECORD and CHORUS right-hand levers to match the new 9-speed

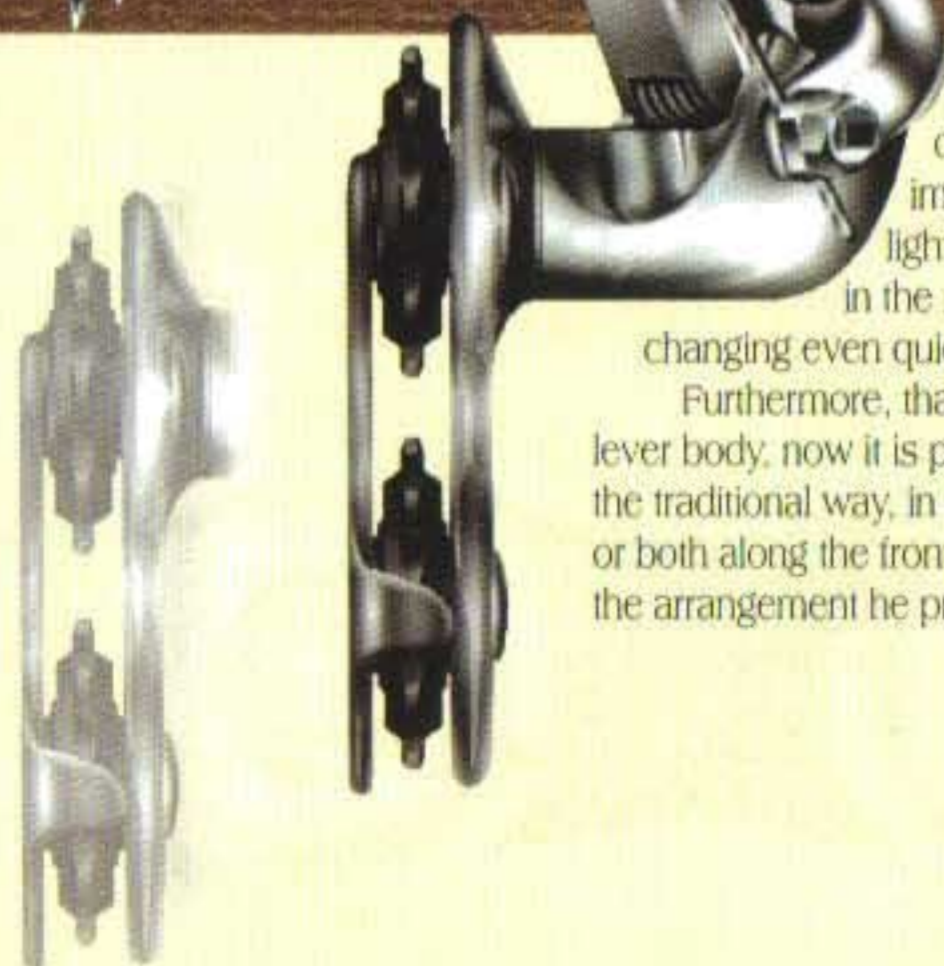

set-up, all ERGOPOWER components have been further improved, resulting in an increased lightness of operation and a reduction in the range of lever travel, making gear-changing even quicker and more intuitive.

Furthermore, thanks to a modification of the brake lever body, now it is possible to run both brake cables in the traditional way, in front and behind the handlebars, or both along the front, thus allowing the rider to choose the arrangement he prefers.

HS-100 "THREADLESS" HEADSET

The interface between CAMPAGNOLO groupsets and the increasingly common stems for forks with unthreaded steerers is now possible, through the introduction of the new "HS-100 Threadless" headset.

The "HS-100 Threadless" is a low-profile headset featuring an innovative system with differential



bearings and double-inclined bearing races, which allow for quicker and more precise adjustment and which give it a life-span superior to that of traditional headsets.

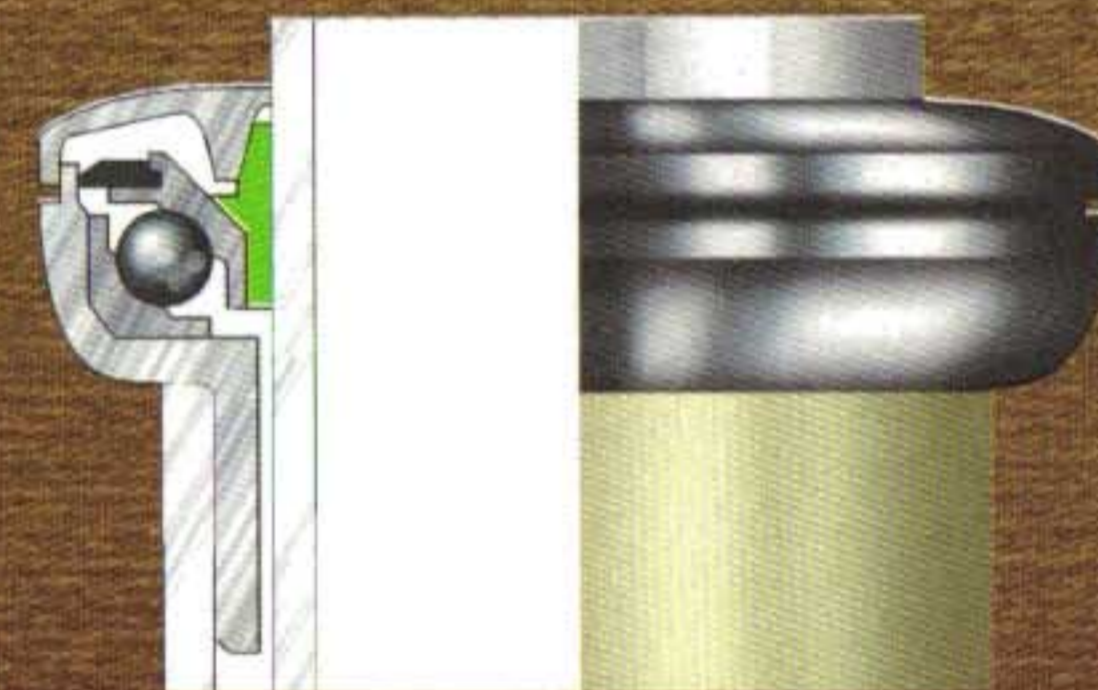

"SELF-CENTERING BEARING SYSTEM"

The exclusive self-centering system of the upper bearing - the "SELF-CENTERING BEARING SYSTEM" (patent pending) - is one of the most important innovations introduced in the new headsets for unthreaded steering columns and bestows on the upper part of the headset the ability to adapt itself perfectly to the geometry of the bicycle.

The main benefit, besides the increased smoothness, is the increased durability of the headset.

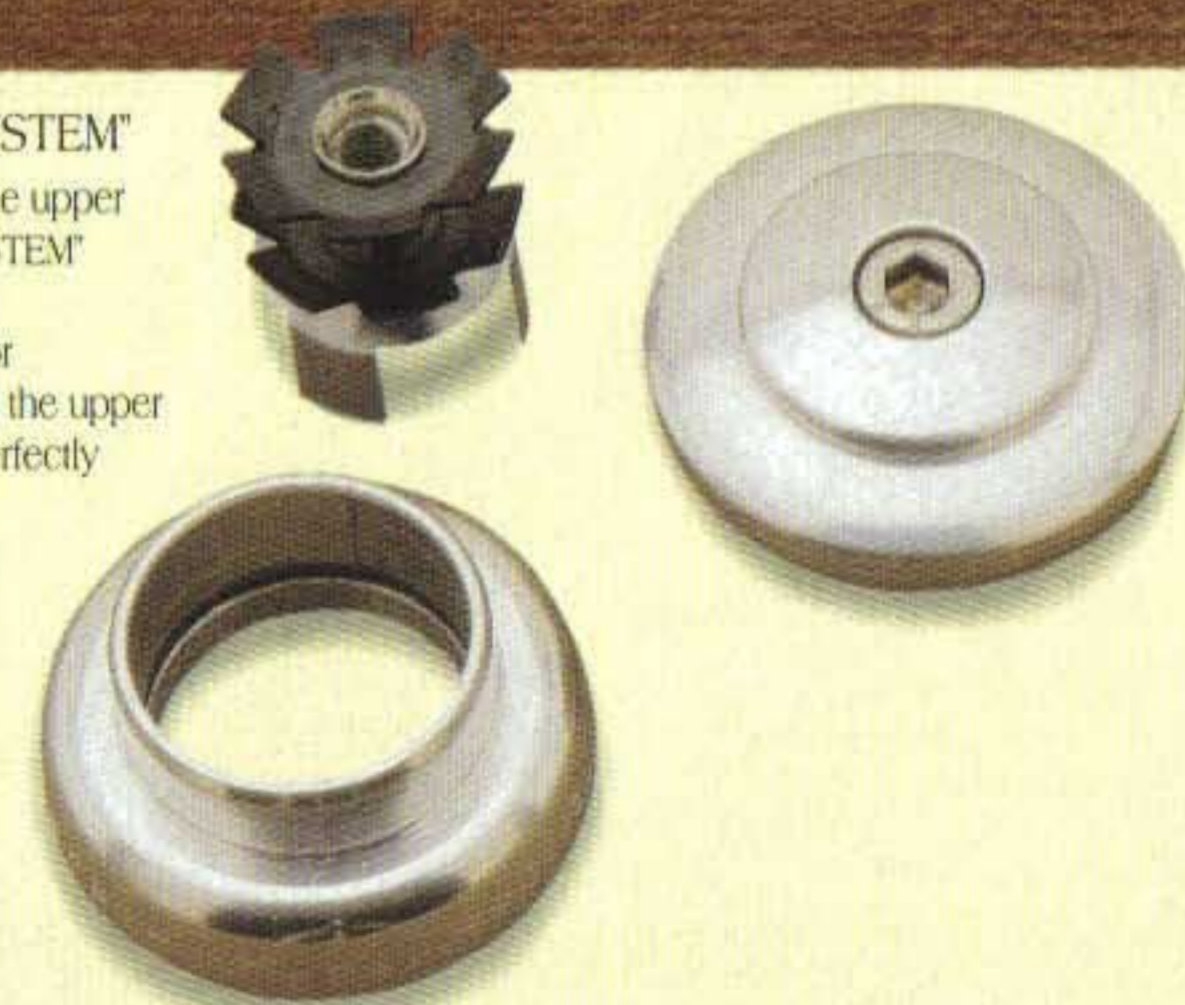

RECORD

NEW QUICK-RELEASE LEVERS 'RECORD'

The quick-release levers are very important for safety, and CAMPAGNOLO, traditionally, has always paid particular attention to these components.

In line with this philosophy, new, even lighter, more efficient and more modern quick-release levers



9 Speed

have been developed for the latest RECORD groupset.

Completely redesigned, lighter levers have been introduced to work with the new skewer nuts made of light anodised alloy.

In order to render the lever movement even lighter and more precise, without making direct contact with

the aluminium of the skewer nuts, new friction-free bushes have been inserted which ensure the quick-release lever's perfect grip on the wheel.

9-SPEED 'RECORD' TRANSMISSION

The latest RECORD groupset comes with the brand-new 18-gear transmission, featuring a special freewheel cassette (with last 3 titanium sprockets in the standard version), chain and other '9-speed' components.

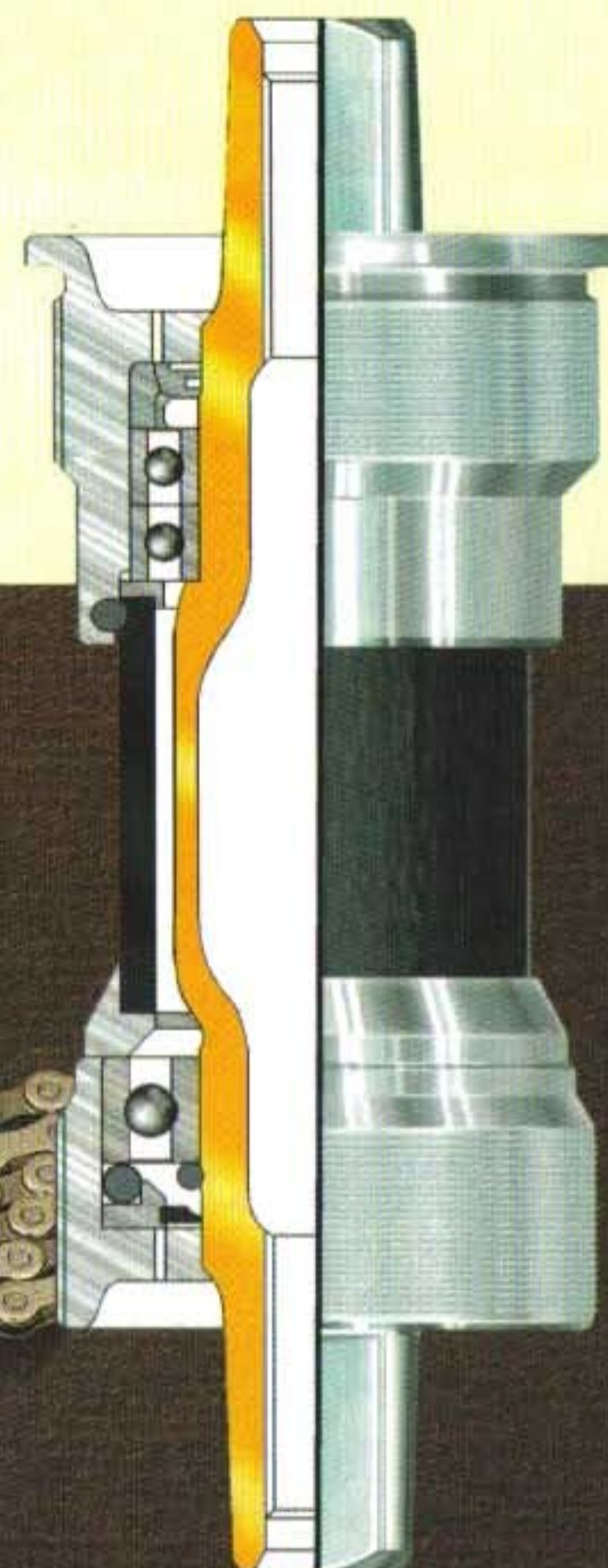

BOTTOM BRACKET

By using research and development which, until now, has been restricted to the aerospace industry, it has been possible to produce a new bottom bracket with an 'oversize' axle, lightened internally, with a profile which would be impossible to achieve through traditional machining methods.

Thanks to this new design, the axle is much lighter but, above all, even more rigid.

An additional reduction in weight has been achieved through the use of carbon fibre for the

main cartridge body, resulting also in increased strength of the bottom bracket.

The smoothness of the bracket is guaranteed by the use of specially-designed bearings which are completely sealed.

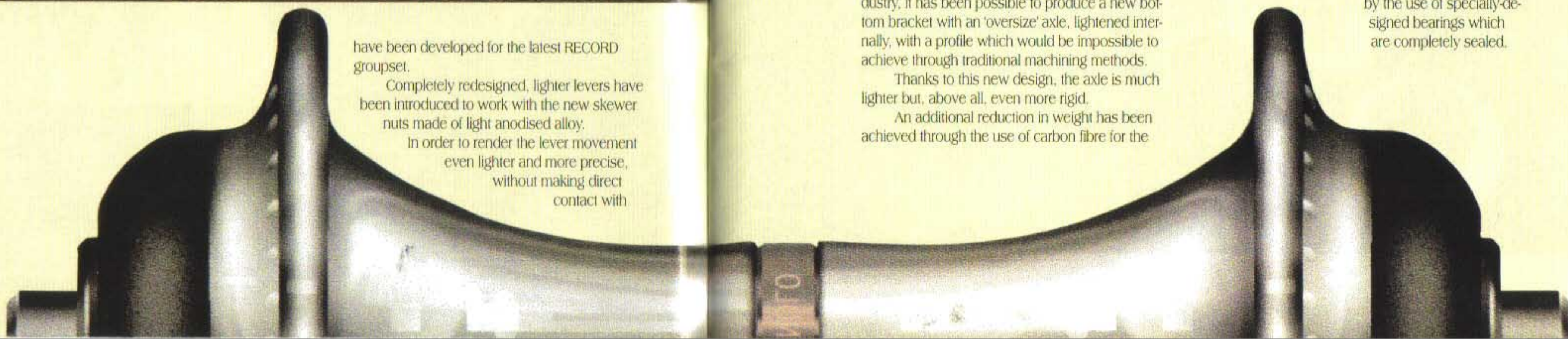

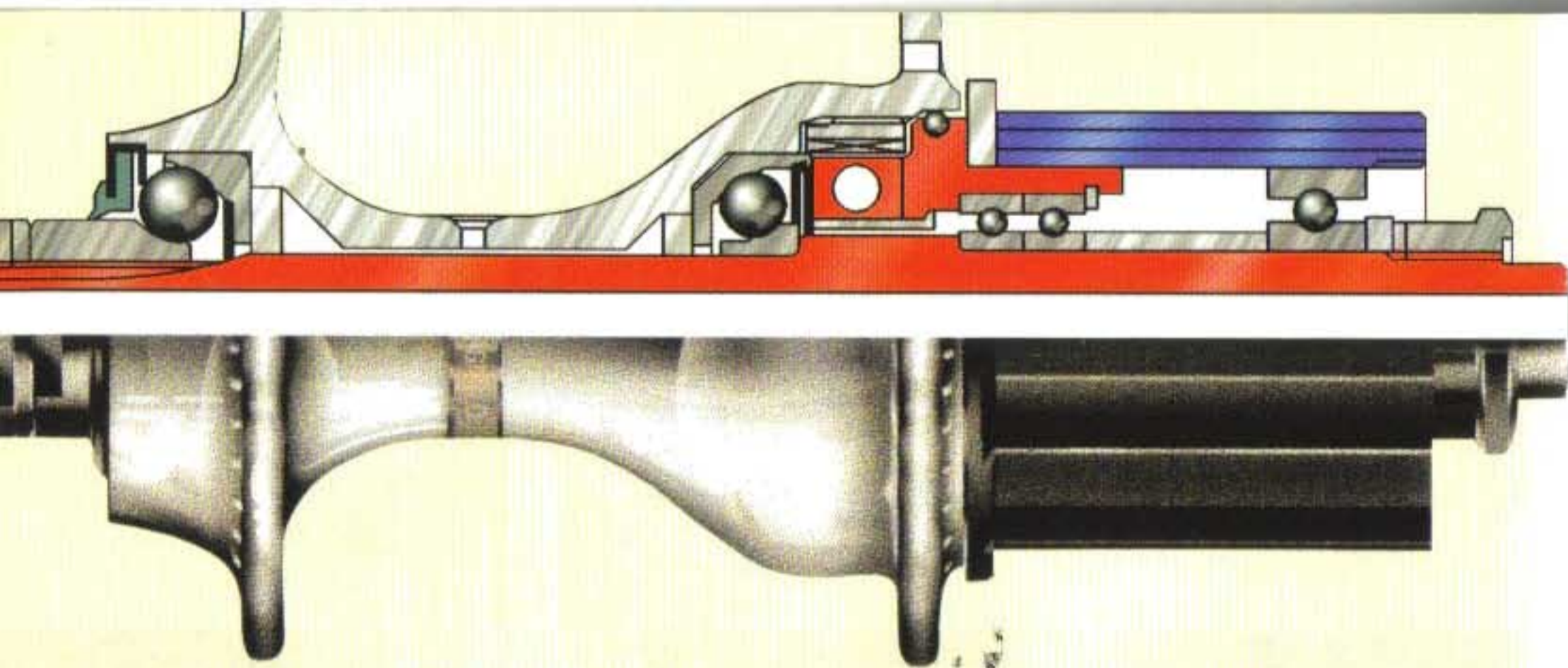

NEW '9-SPEED' RECORD HUBS

New components and solutions have been adopted as standard on the RECORD hubs, thus obtaining a notable reduction in weight, without loss of strength or long-lasting reliability.

Titanium has been used in the rear hub, both for the axle and the inner freewheel body, while for the outer, splined body, a top-quality aluminium alloy has been used.

Through these components alone, weight has been reduced by a significant 95 grammes. If the 26 grammes eliminated from the front hub and the 20 grammes from the new quick-release levers are added, the whole ensemble has been lightened by more than 140 grammes.

In fact, the new front hub axle is also in titanium and runs on new bearings which are totally sealed.

RECORD HEADSET

The research carried out on threadless fork columns for the new headset series has produced noticeable benefits for the traditional RECORD headset as well, which is now much lighter, thanks to its much

more compact "LOW STACKING HEIGHT" design.

The headset is produced with the same system of differential bearings and double-inclined bearing races, which makes for easier and more precise bearing adjustment, guaranteed to remain 'set' over time.

Both the upper and lower cups feature the traditional lubrication system and are protected by sealing washers.

REDUCTION IN WEIGHT

An integrated development of products and technologies over the years has enabled CAMPAGNOLO to achieve a gradual and constant reduction in the weight of components. For example, from 1995 to today it was possible to obtain an overall weight reduction on the RECORD groupset as shown in the chart.

RECORD *



RECORD

The Tour de France, the Giro D'Italia, the World Championship, the Milan-Sanremo: all legendary races which evoke memories of the great champions who have written the history of this sport.

One name is synonymous with these prestigious races and many others: RECORD, the groupset which has won so often alongside legends like Coppi and Merckx, Hinault and Indurain and many other greats who have filled the dreams of the fans.

Although fully aware of its glorious past and present, CAMPAGNOLO looks to the future, because innovation is part of its philosophy, and because only in this way can it continue to be a legend for the champions yet to come.

For this reason, the RECORD groupset, now with 18 gears, sees the introduction of important innovations which, together with the selective introduction of new components in titanium, have brought about a whole range of performance improvements as well as a notable increase in lightness.

RECORD: the legend continues.

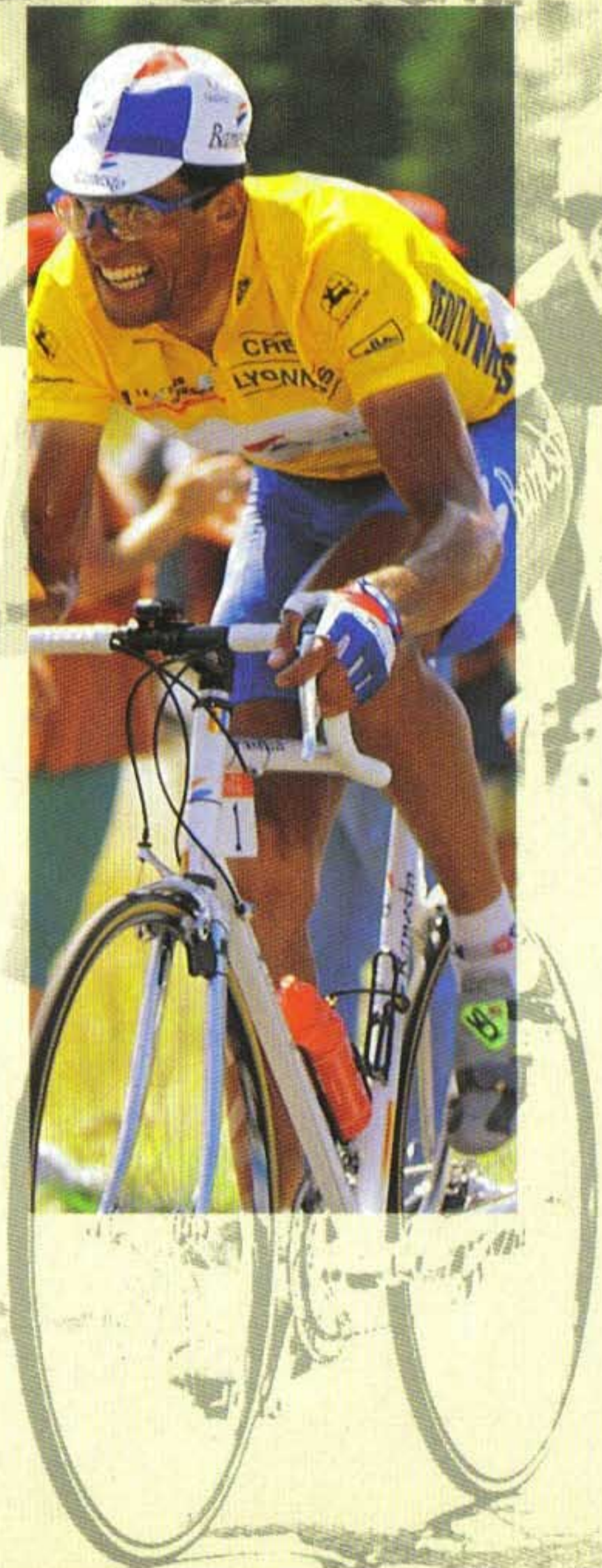

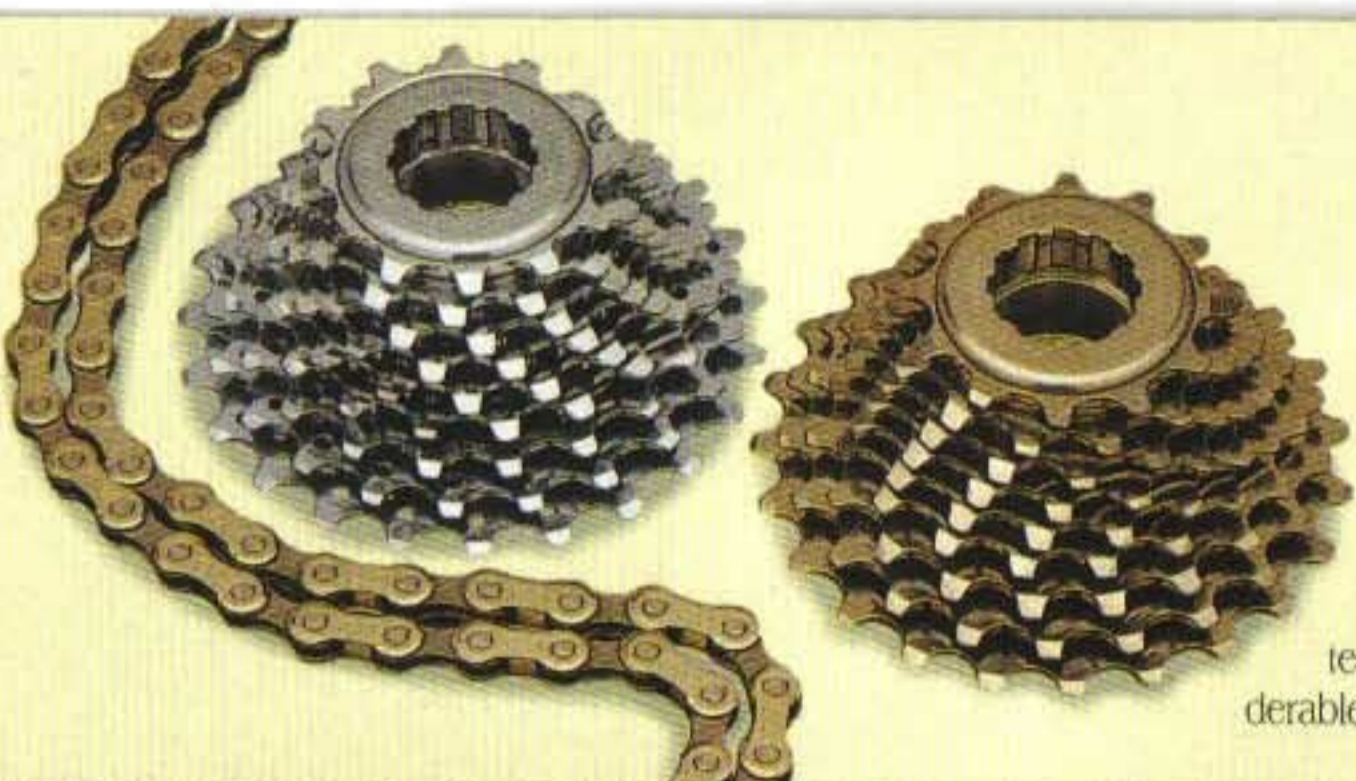

9-SPEED CHORUS TRANSMISSION

The CHORUS groupset, too, is also equipped with an 18-gear transmission, thanks to the development of the freewheel cluster and the brand-new RECORD 9-speed chain. The standard freewheel cluster in steel can be substituted by the titanium version, which offers a considerable weight saving with no loss in performance.

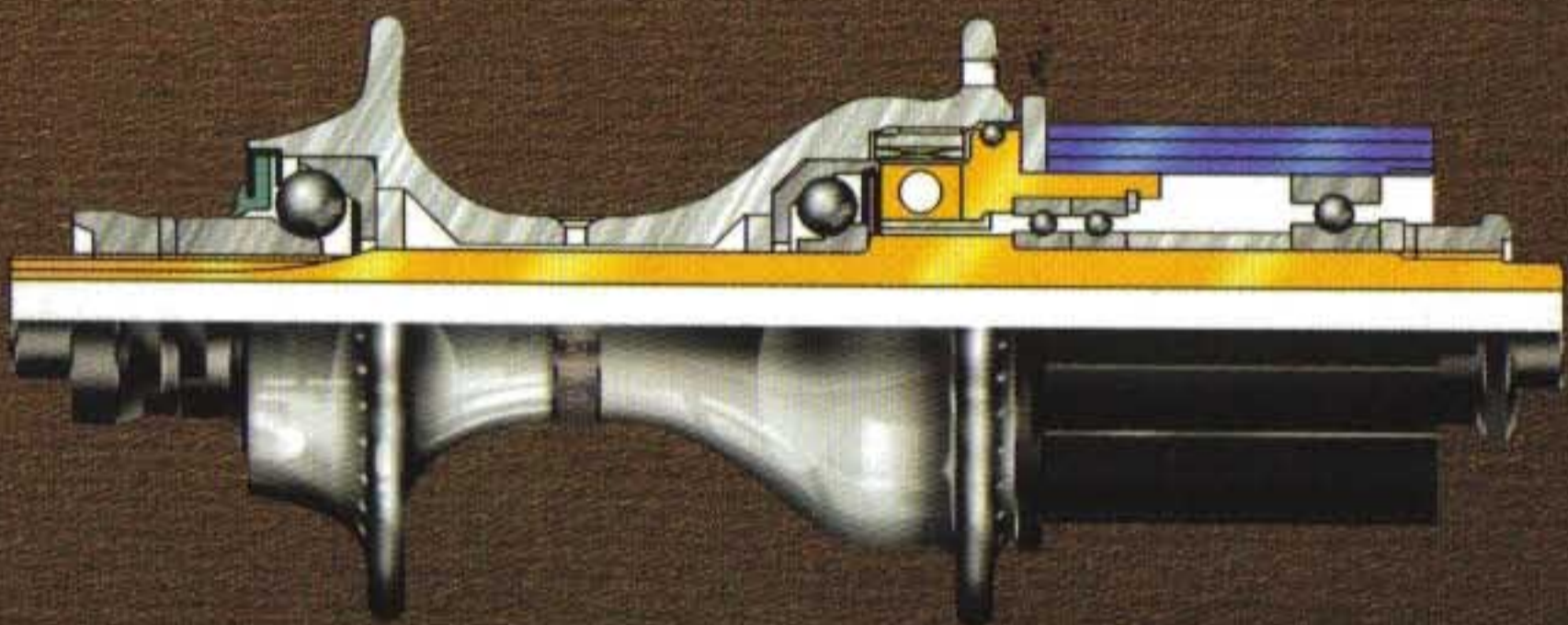

REAR HUB

The new CHORUS 9-speed rear hub has been produced using a special light aluminium alloy for the innovative outer, splined freewheel body, resulting in a very useful reduction in weight. This outer body accepts 9-speed freewheel clusters in both steel and titanium, as required. All CHORUS hub bearings are completely sealed.

NEW QUICK RELEASE LEVERS

To complete the CHORUS hubs, new quick release levers of ultra-modern design have been produced, which are much lighter and feature aluminium bosses, inside which the release levers operate on treated steel bushes. The new CHORUS quick release levers help to save a further 19 grammes.

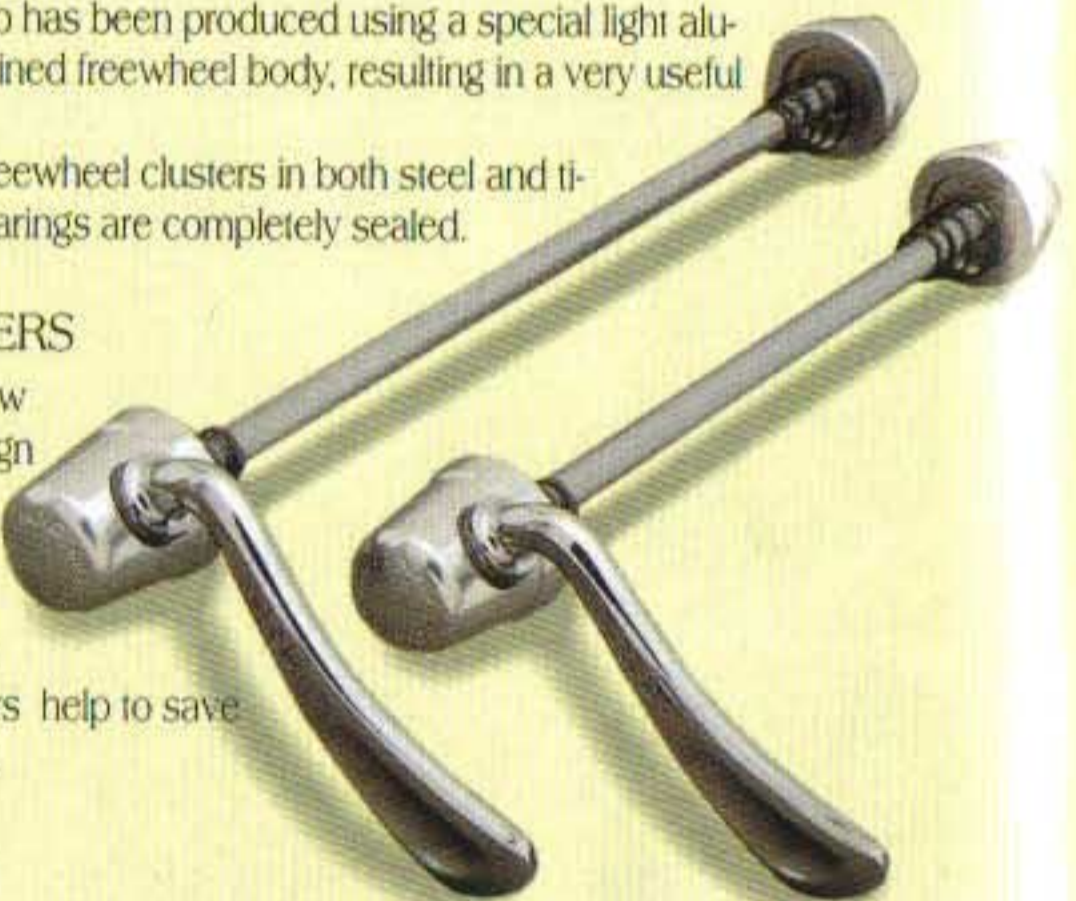

HEADSET

The headset of the new CHORUS group benefits from the same "LOW STACKING HEIGHT" construction developed for the HS-100 "THREADLESS". Increased durability over time and even smoother, more controllable steering of the bicycle have been achieved through the adoption of differential ball-bearings, all perfectly sealed and protected from external elements, such as water and mud.



CHORUS

The Chorus groupset, which is also equipped with 18 gears, has virtually the same features as those of the RECORD groupset, albeit less sophisticated and more economical. Chorus is the ideal groupset for those who compete or for those who expect from their bike the highest performance combined with faultless functionality. A 9-speed freewheel, ERGOPOWER controls, DUAL-PIVOT brakes and a low-profile headset are all high-technology features employed in the Chorus groupset, making it a top-performance product for use on the finest bikes.



ATHENA



ATHENA DUAL-PIVOT BRAKES

A basic characteristic of dual-pivot brakes, found also in the RECORD and CHORUS groupsets, is the use of a brake caliper whose fulcrum is located at a greater distance from the pulling point of the brake cable.

This feature brings about an even greater braking force but also causes an imbalance between the two calipers. For this reason, CAMPAGNOLO has created a special, exclusive cam which not only augments the braking effect but, at the same time, renders it notably more sensitive and controllable and, even more importantly, perfectly balanced because it is applied equally and with great precision on both sides of the rim.

Furthermore, the brake shoe with its ball joint mounting allows perfect contact between the brake blocks and the rim wall, thus guaranteeing opti-

mum braking right from the start. Both these innovations have been introduced on all dual-pivot brakes in the CAMPAGNOLO range.

ATHENA ERGOPOWER

Equipment which combines high functionality with maximum comfort guarantees superior performance with less effort. The ERGOPOWER controls of the entire 1997 range have been improved even more thanks to a reduction in the 'travel' of the levers, which are also fitted with return springs that allow even smoother operation. A complete re-design of the rack and pinion has optimised the phasing between the change-up and change-down mechanisms leading to a quick and precise movement of the chain with the shortest possible lever movement.

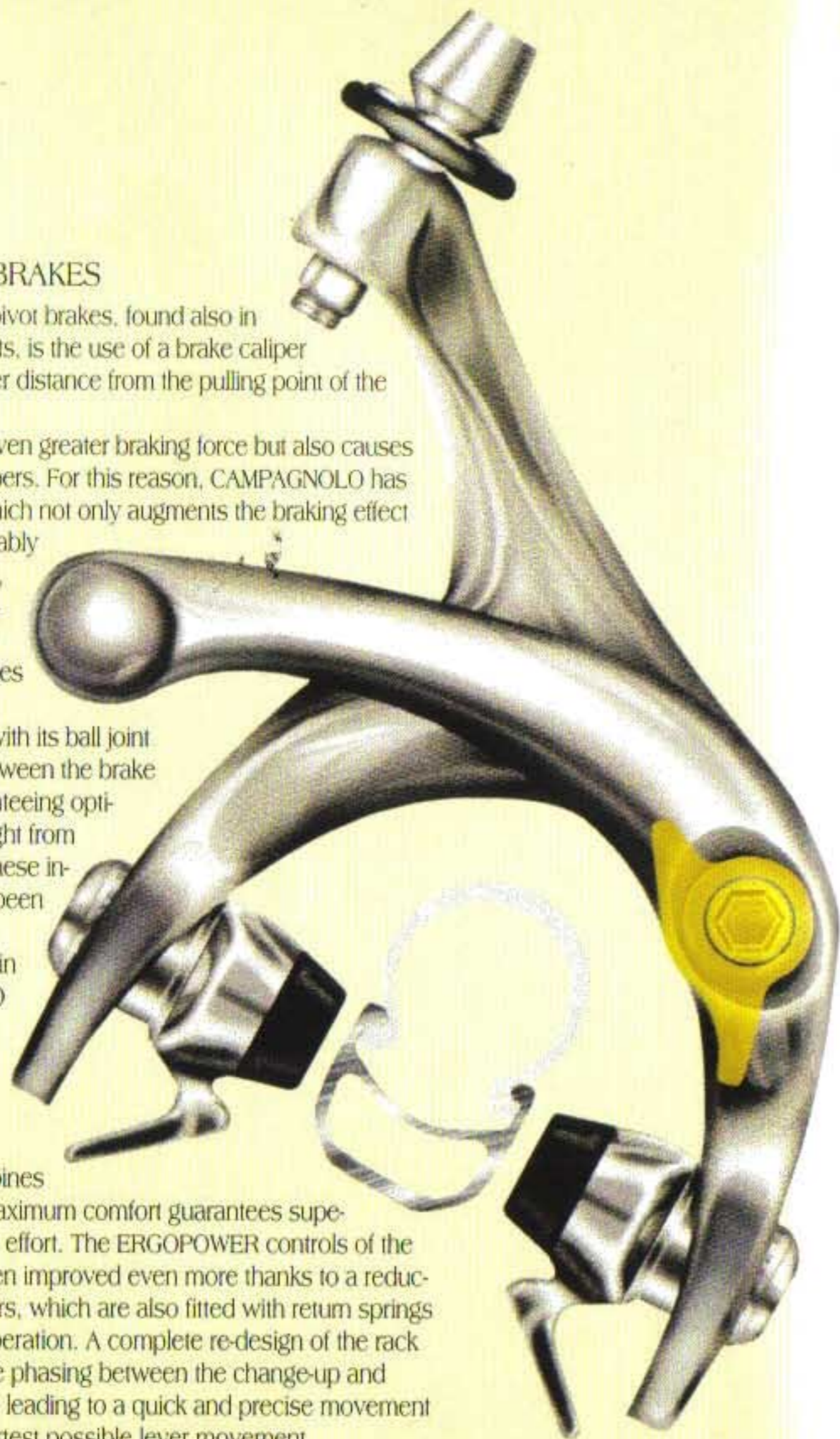

Suited for any specialism, be it full-blown competition, recreation or club riding, the Athena groupset has been created using the latest technologies, which have equipped it with the very same features of functionality and quality as those found in the prestigious RECORD and CHORUS groupsets used by the top professionals.

With its integrated EXA-DRIVE transmission system and 16 or 24 indexed gears, DUAL-PIVOT brakes and ERGOPOWER levers housed in a carbon-fibre body, the ATHENA groupset has all the latest features, which makes it ideal for those who are looking for the optimum mix of price and quality in top-of-the-range bicycles.

ATHENA

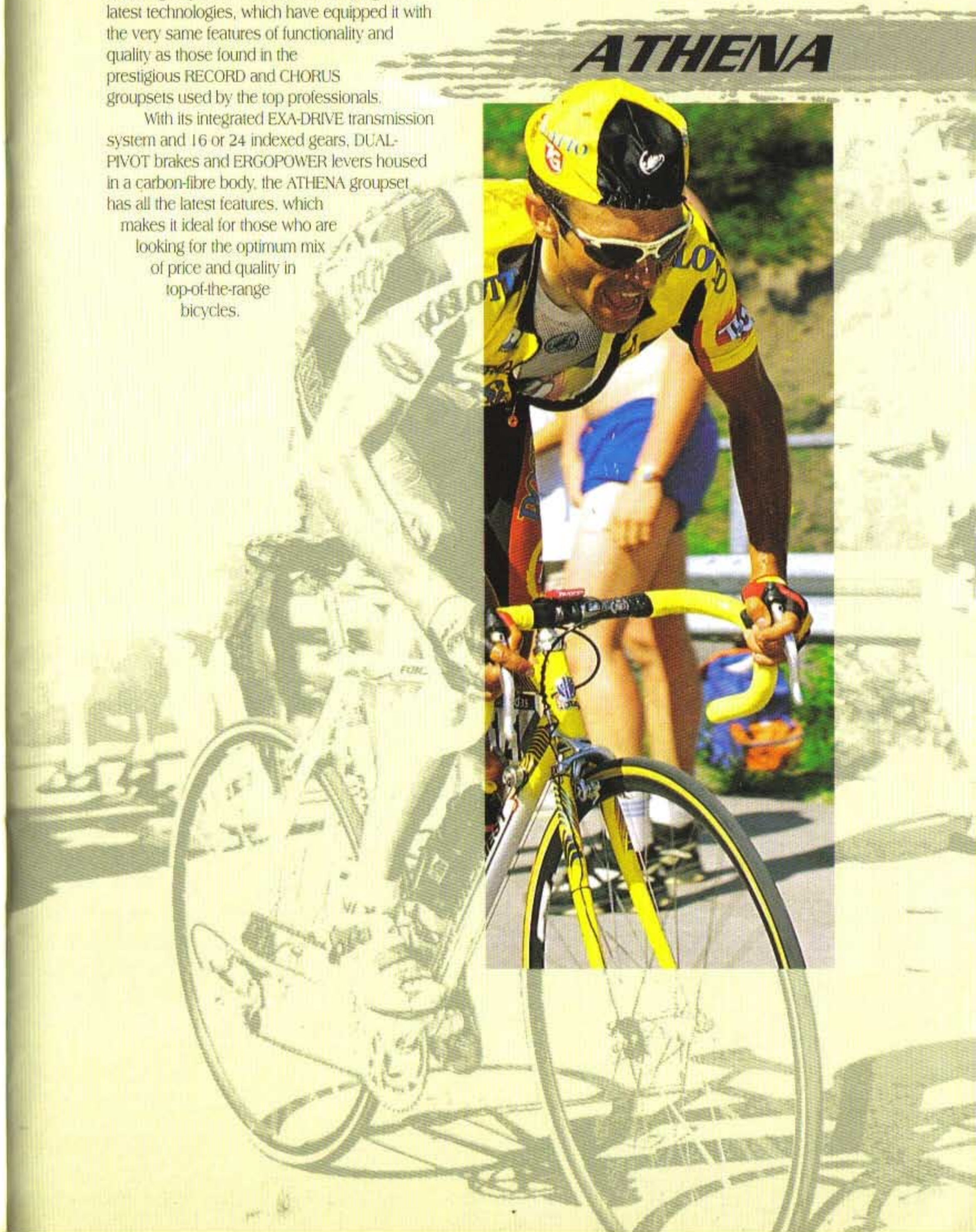

VELOCE

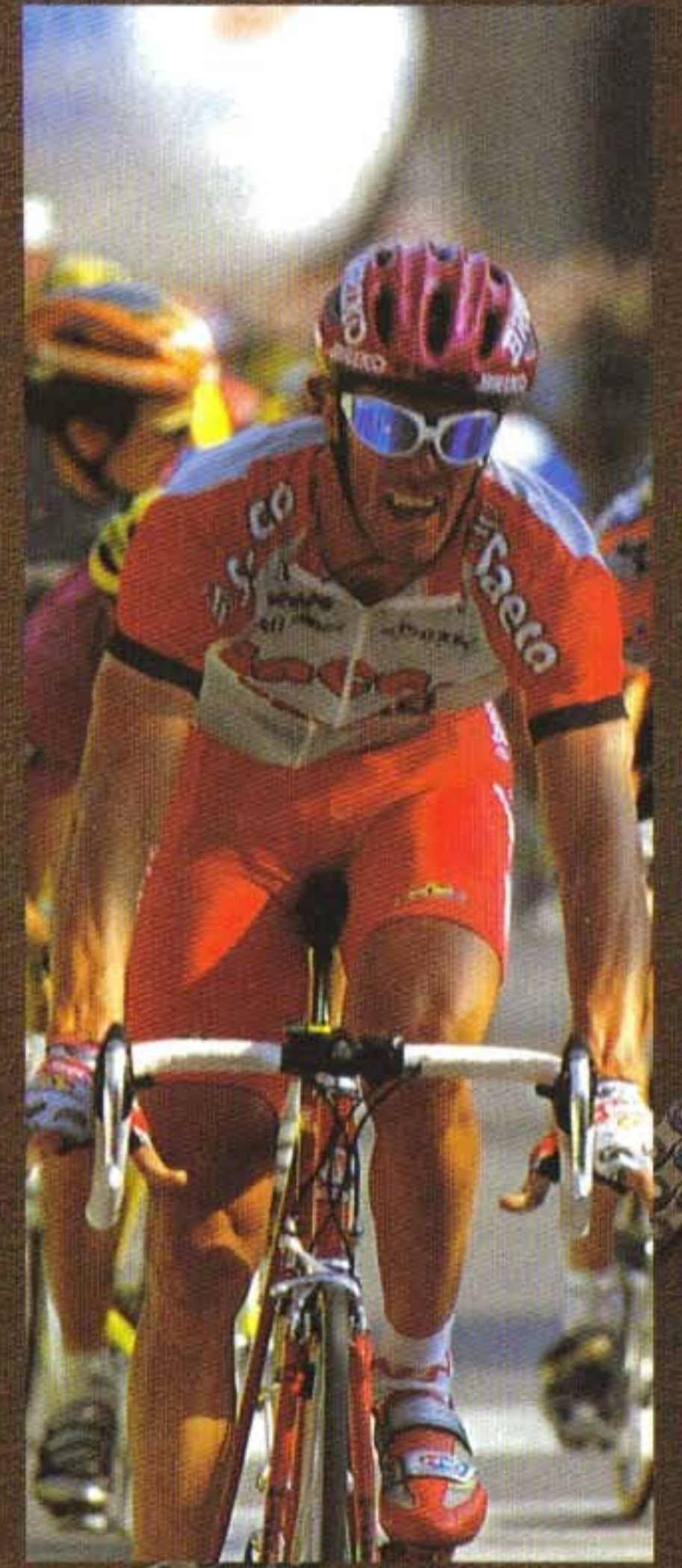



TRIPLE COMPONENTRY

The legendary versatility of the CAMPAGNOLO groupsets facilitates the building of bikes for the greatest champions as well as for those who want to go cycletouring in the most comfortable way possible.

The option of equipping the whole range of groupsets with 16 gears and triple componentry is further confirmation of our dedication to meeting the requirements of all users.

Chainsets, rear mechanisms and derailleurs are all compatible with the traditional groupsets and the ERGOPOWER controls, which, as standard, are pre-set for use with triple componentry.



ERGOPOWER

The ERGOPOWER controls have been designed to provide the fastest possible gear-change, in an intuitive way and with the maximum saving of energy on the part of the rider.

A further improvement, in terms of smoothness of operation, has been achieved on all the left-hand controls (for both double and triple derailleurs) through the insertion of a compensating spring inside the lever body.

This noticeably reduces the effect of the derailleur return spring and allows for even easier and more precise changes.

Designed with the most advanced technologies, the Veloce groupset, thanks to its extreme versatility, is aimed at a wide range of cyclists, from those who wish to participate in high-level competition to those who see in cycling a healthy and pleasant way of doing sport in their free time.

Produced with the same philosophy as that behind the top-of-the-range groupsets, the Veloce groupset has the same degree of safety and reliability as those traditionally present throughout the whole Campagnolo range.

These features make the Veloce groupset the standard for those who seek quality and performance at a modest price.

VELOCE

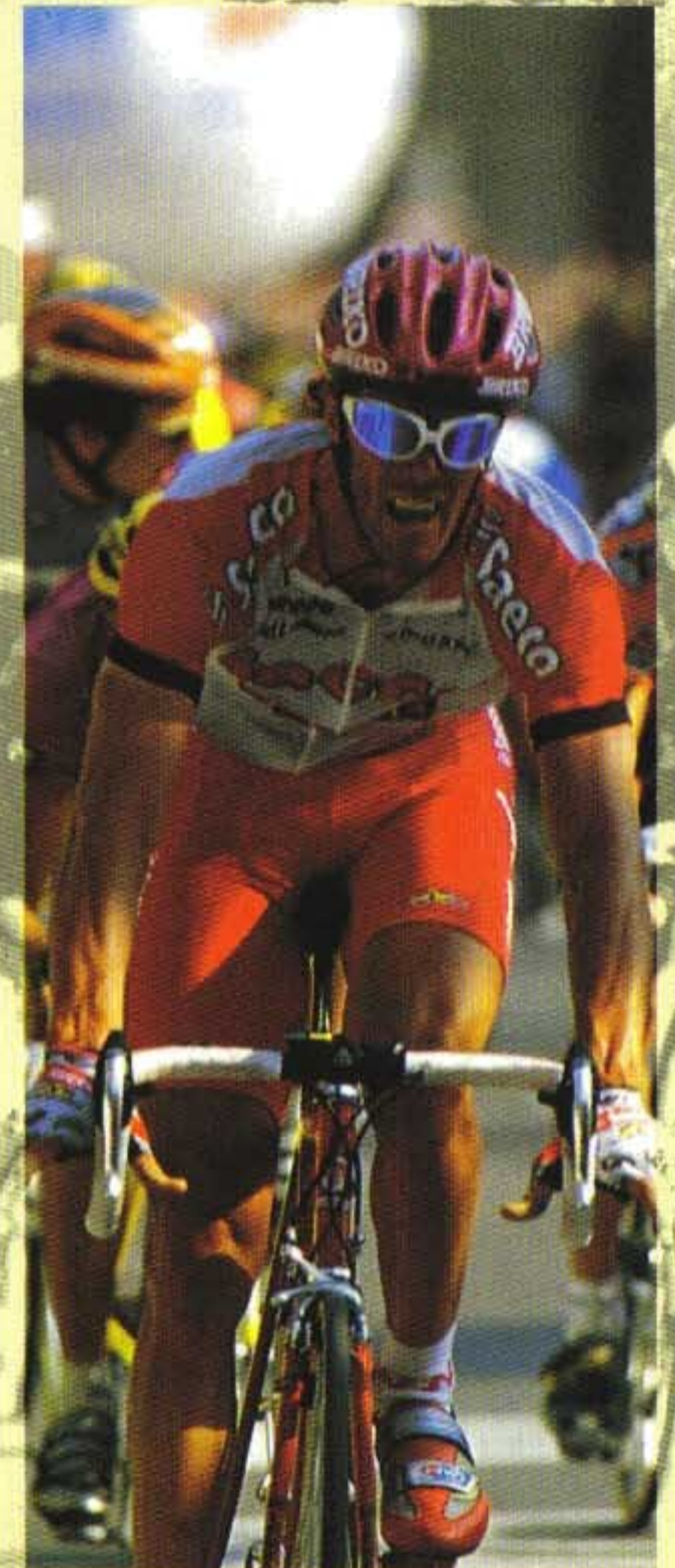

MIRAGE

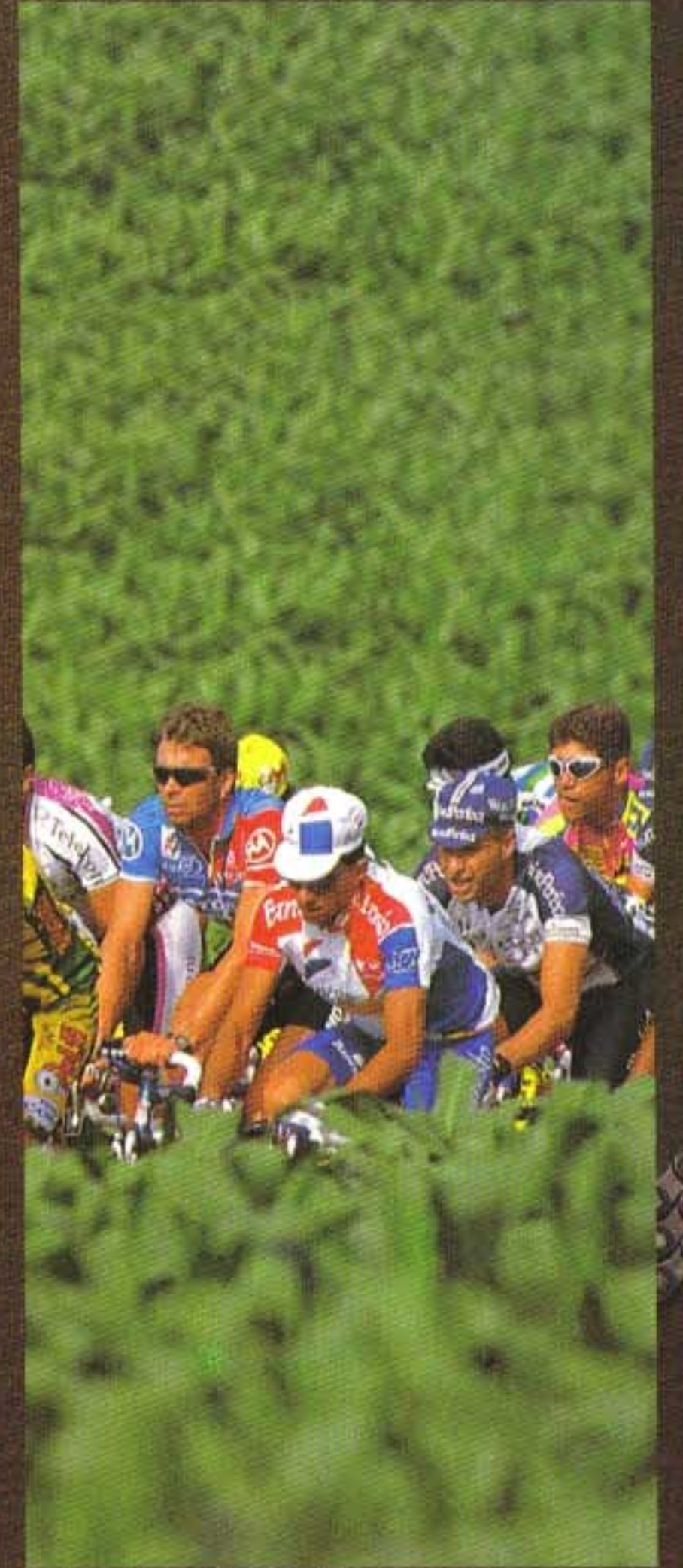

ERGOPOWER

Greater comfort for the rider means less energy expenditure, which leads to either a reduction in effort or increased performance. It is in this context that the ERGOPOWER controls have proved to be one of the great innovations, since they allow the rider to change gear and move from one chainwheel to another, without having to take his or her hands from the handlebars, thus remaining always in control of the bike.

One of the most important features of the controls is the way they enable the operating cables to be "hidden" along the length of the handlebars. All ERGOPOWER controls, throughout the entire range, allow the rider to choose which side of the bars to "run" the cables, according to his or her personal preferences.

REAR HUB

Without the help of a professional, some aspects of the maintenance of one's bike can pose real problems for those of us who are not expert mechanics.

In order to offer products with an ever-higher level of performance and which require the minimum maintenance, MIRAGE and AVANTI rear hubs have been fitted with new bearings which are completely waterproof and sealed, thus eliminating the need for further lubrication.

This, in addition to the high quality of the bearings, guarantees a life-span which was once exclusive to the top-of-the-range CAMPAGNOLO products.

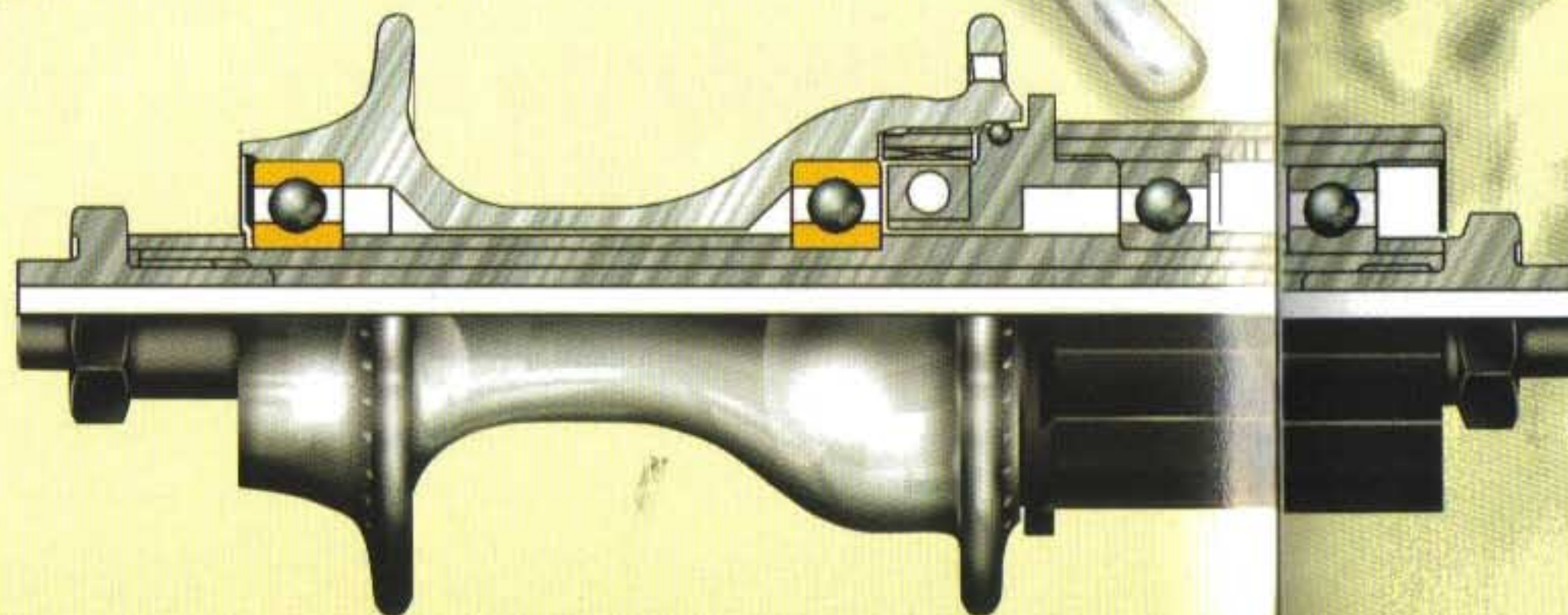
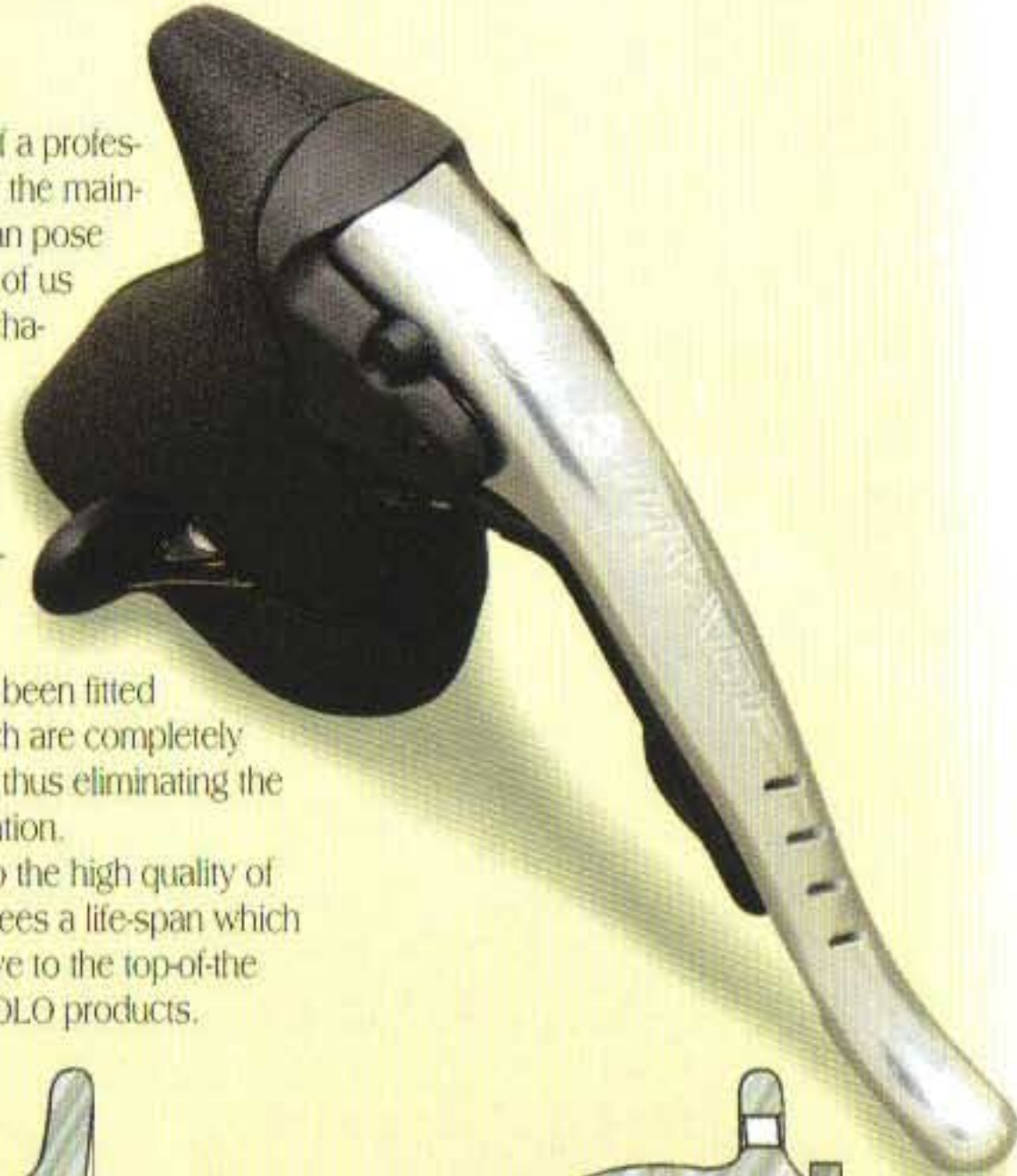

MIRAGE

The Mirage groupset, even if destined for use on less expensive bicycles, is aimed at the club rider, recreational rider or tourist, who requires a medium priced machine without having to forsake the basic characteristics of the top-of-the-range products.

This has been achieved through the incorporation of technologies employed in the more advanced groupsets, together with the traditional polished and anodised finish.

Furthermore, the Mirage groupset has been designed for easy, automated assembly on the production lines of the world's leading bike builders.

For the first time ever, Campagnolo brings cutting-edge technology within reach of everybody.

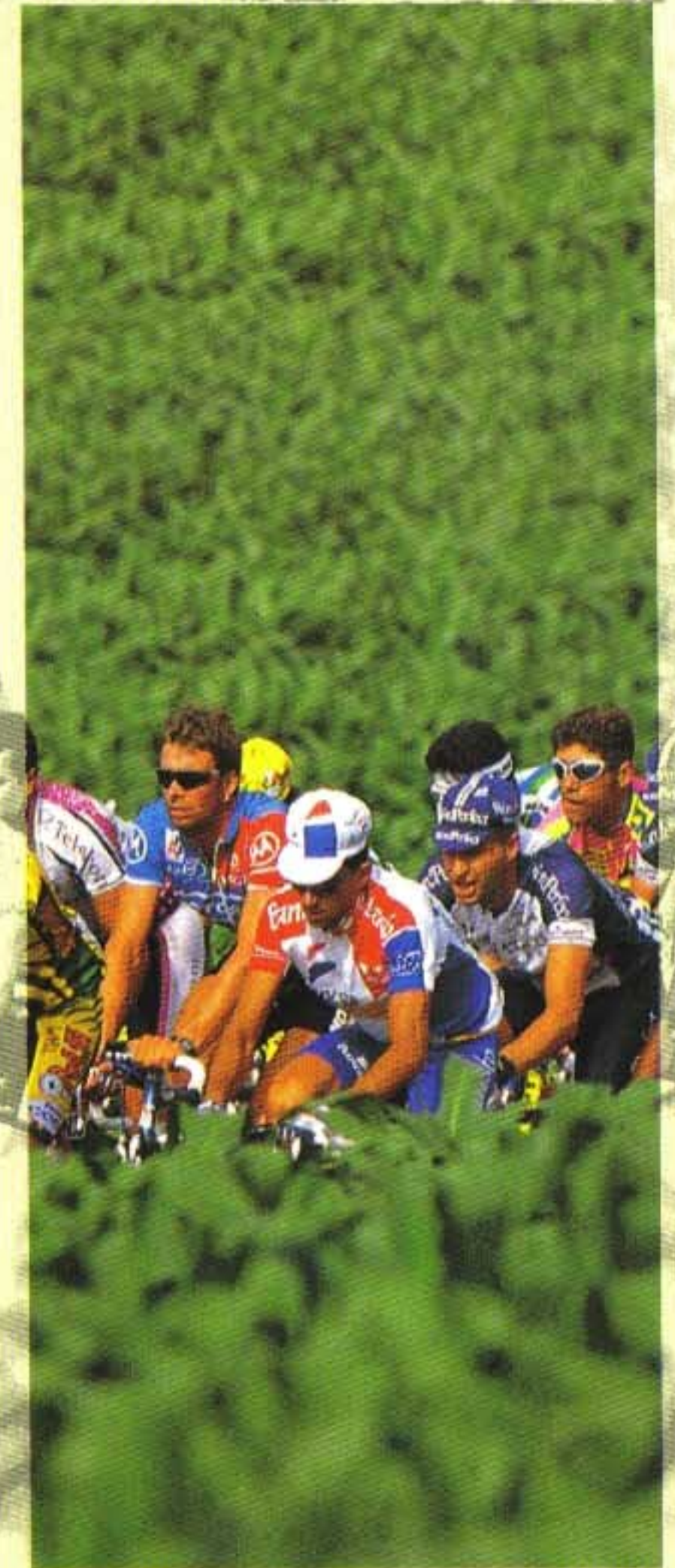

AVANTI

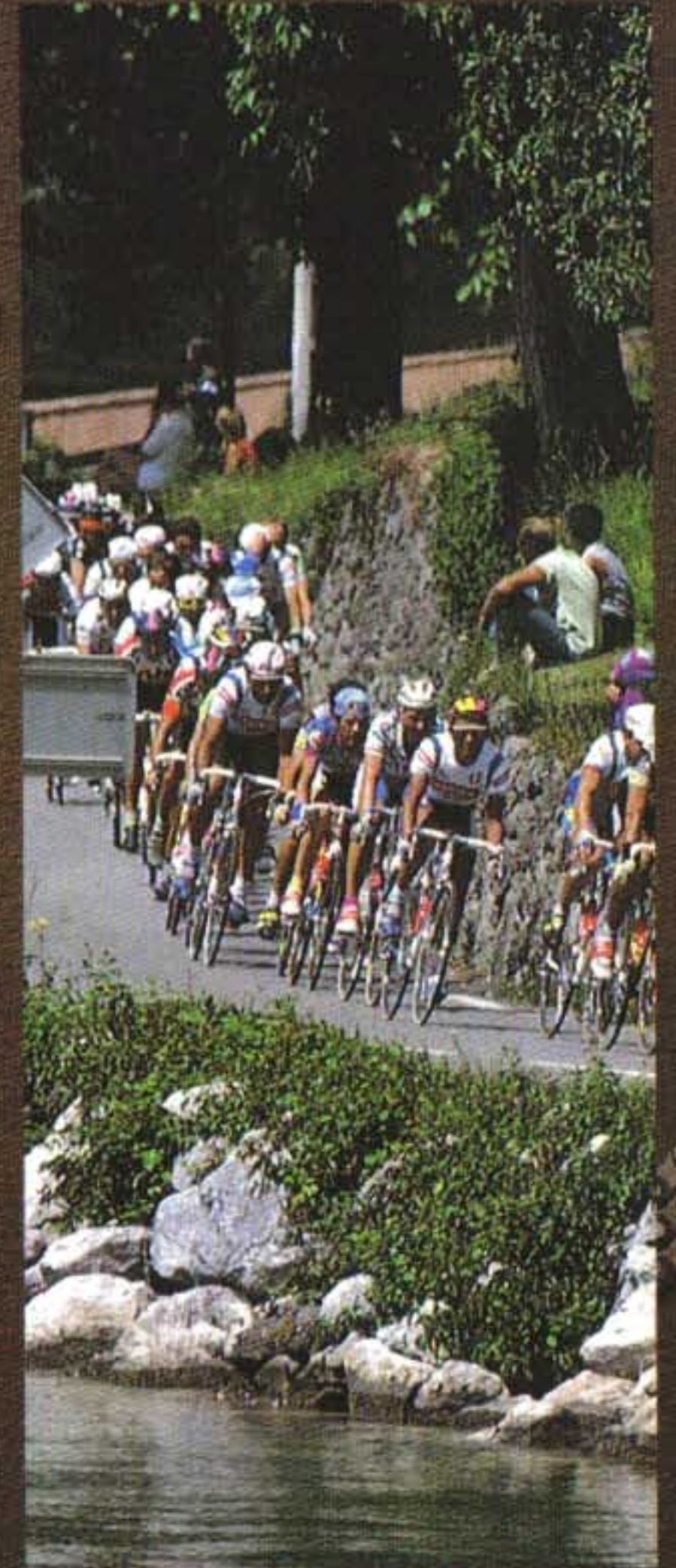



EXA-DRIVE SPROCKETS

With the EXA-DRIVE system, a feature common to the entire CAMPAGNOLO range, it is now possible to change gear or move from one chainwheel to another, regardless of the load on the chain as, for instance, when tackling a tough climb.

This feature, much appreciated by riders, who benefit both in terms of speed of operation and comfort, has been made possible by the introduction of new sprockets on the rear hub designed to allow perfect gear changes



both up and down the freewheel.

The special design of these sprockets provides not only superior gear-changing but also offers the great advantage of quietness in operation and reduced wear and tear.

EXA-DRIVE CHAINWHEELS

The EXA-DRIVE principle has also been applied throughout the range to all chainwheels, including the triple, thus guaranteeing perfect derailing.

The special internal and external profiling of the chainwheel teeth and the precise positioning of the steel 'lifting pins' ensure a smooth and rapid switching of the chain from one chainwheel to another.

This particular arrangement means that the absolute minimum area of the chainwheel is involved when derailing, since few teeth are called into play.

This is, in fact, an important improvement for changing from the small chainwheel to the large chainwheel and vice-versa. Because of this, it is no longer necessary to ease the pressure on the pedals, which can lead to a considerable loss of speed, in order to change from one chainwheel to another.

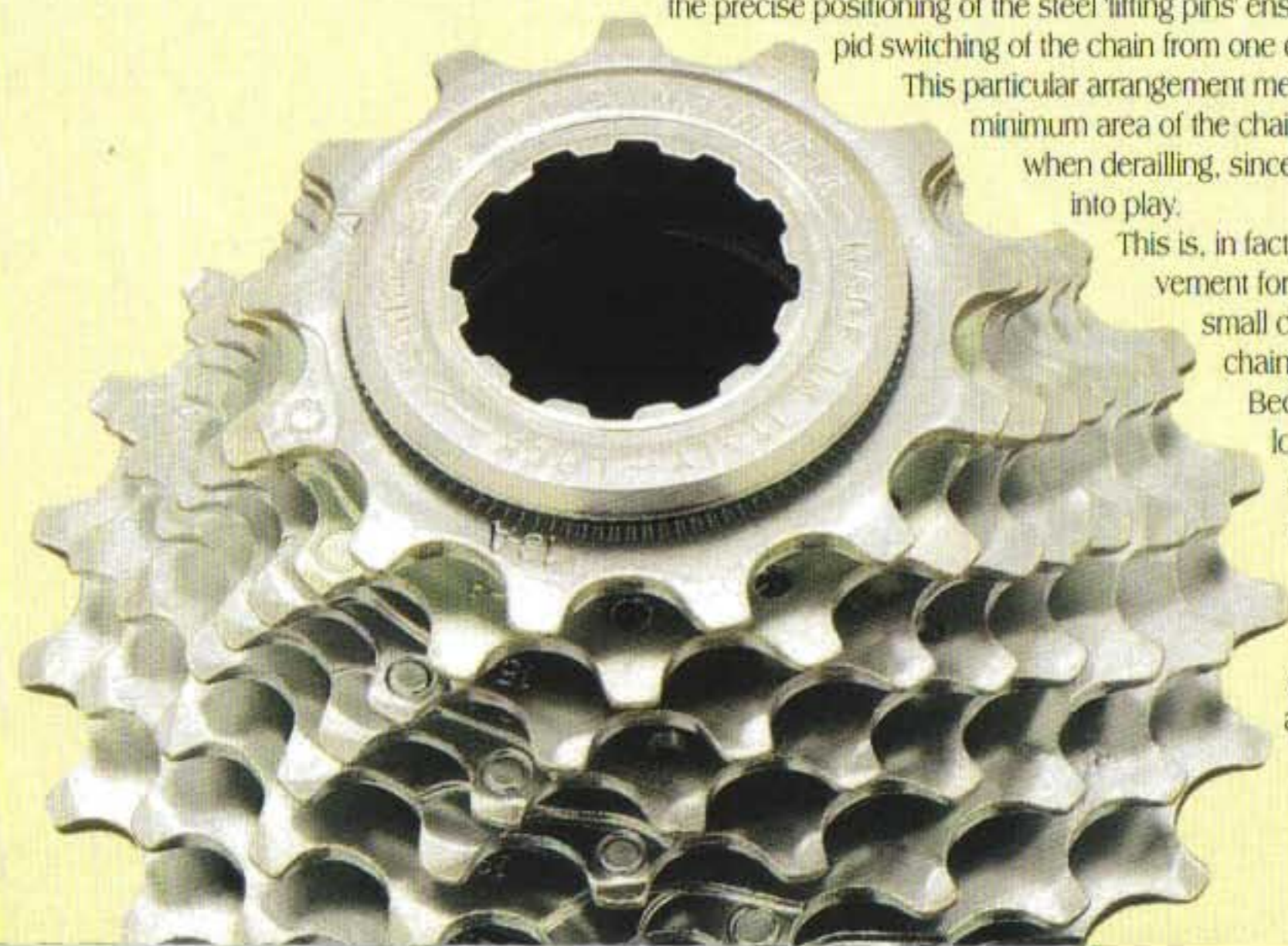

The Avanti groupset is the ideal choice for newcomers to cycling, or for those youngsters on a limited budget who want to compete but who do not want to forgo the performance and reliability of the top groupsets.

The Avanti groupset, with its anodised finish (a feature of all Campagnolo groupsets) has, as standard, the same EXA-DRIVE transmission common to the whole range.

The Mirage groupset can be used with 16 or 24 gears, thus meeting the needs of the most demanding riders in any situation.

AVANTI

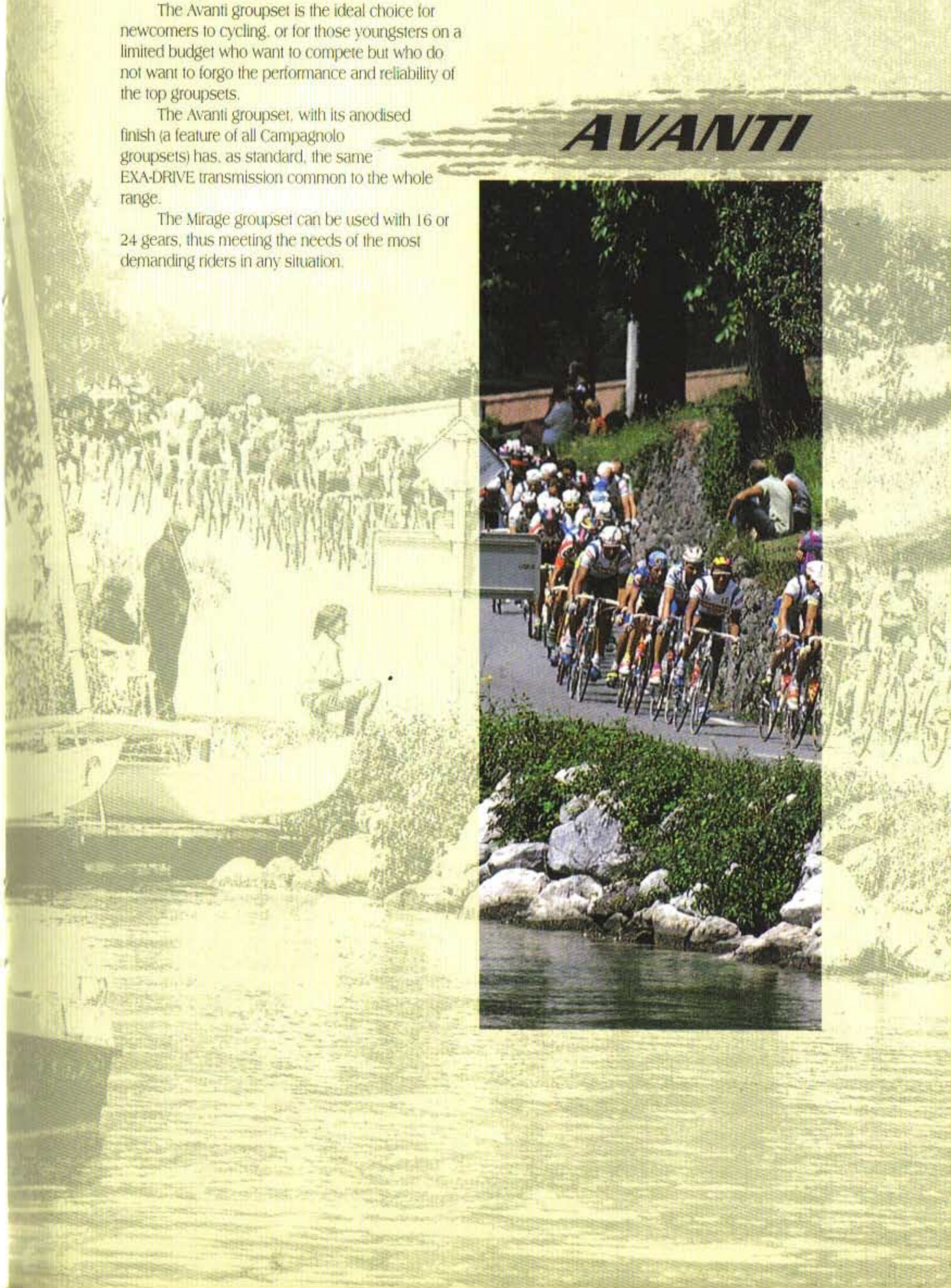
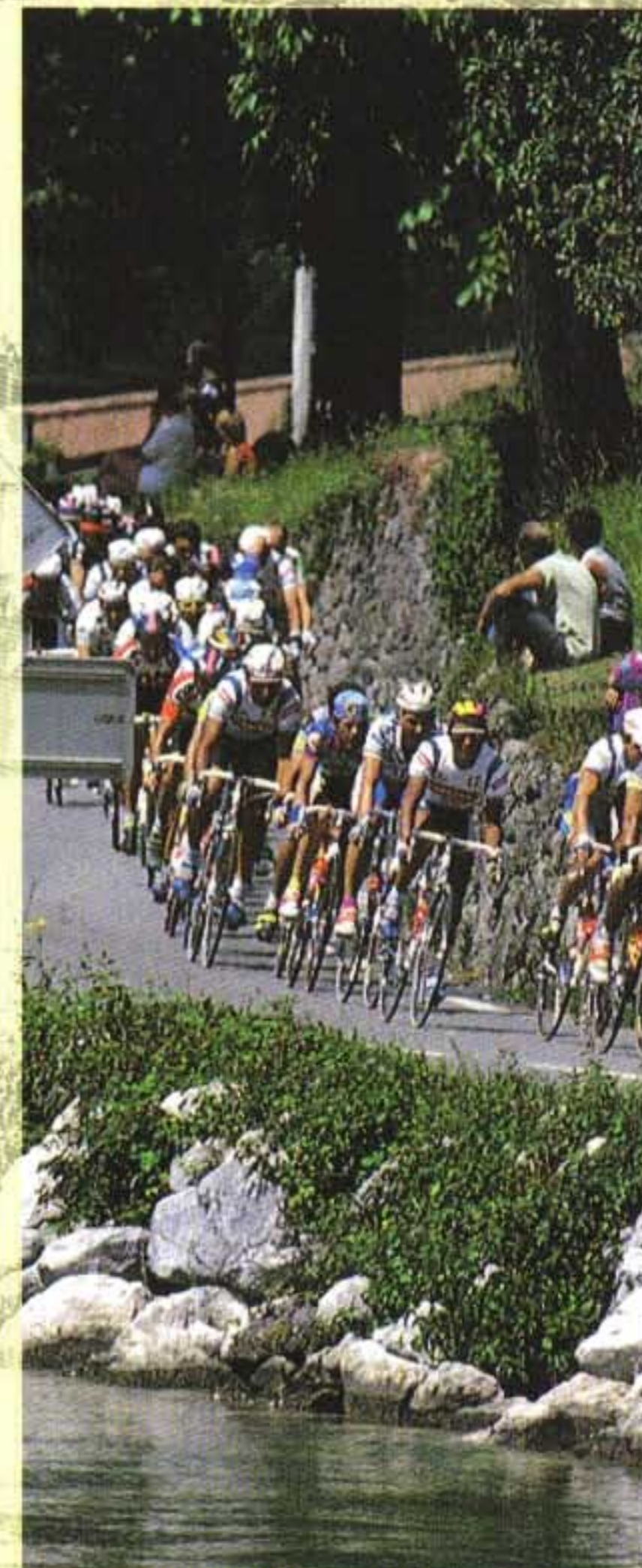

SPEED TH

The world of triathlon is always on the lookout for the latest technological innovations that might help shave off those few seconds that can often lead to victory.

For this reason, Campagnolo is more and more committed to offering a special range of wheels and components, SPEED TH, for fitting to the bikes of the champions in this specialism.



In fact, Campagnolo's presence alongside the top riders, such as GREG WELCH, FERNANDA KELLER, OSCAR GALINDER and DANILO PALMUCCI, is emblematic. These riders, and many others like them who have chosen the technology of the champions, have chosen CAMPAGNOLO.

RECORD PISTA



On the track, as elsewhere, CAMPAGNOLO can not avoid its leading role, accompanying all the top riders and gathering with them a string of successes too numerous to mention.

Our history of Olympic, World and Hour records is unparalleled and the envy of all.

On the road or track, wherever there is competition, CAMPAGNOLO is there with the leading riders and champions, regardless of specialism.

Now, with the SHAMAL and GHIBLI wheels designed especially for the track, CAMPAGNOLO brings within reach of everybody a complete range of products aimed at providing Record performance.



RECORD PISTA

WHEELS

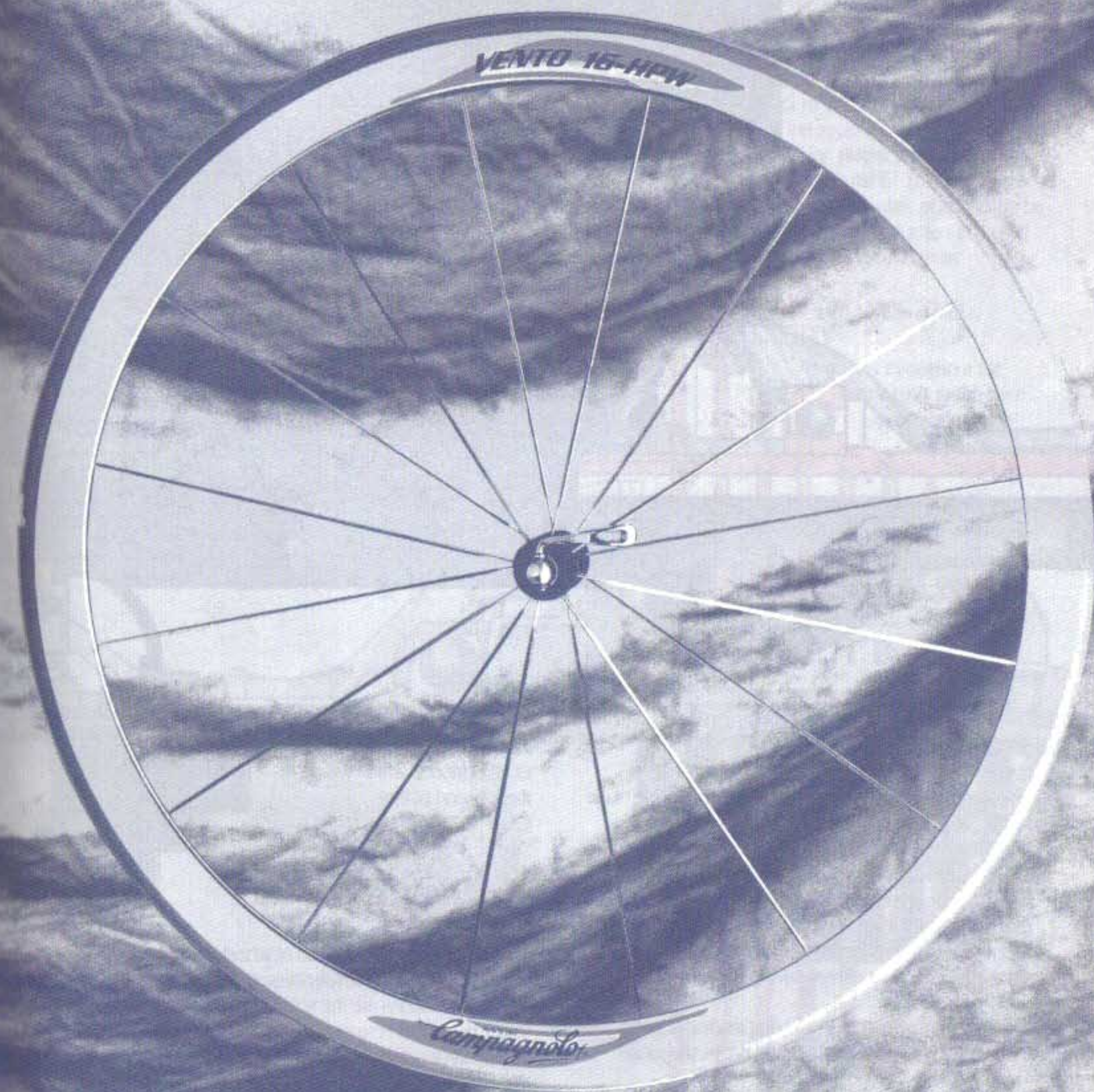
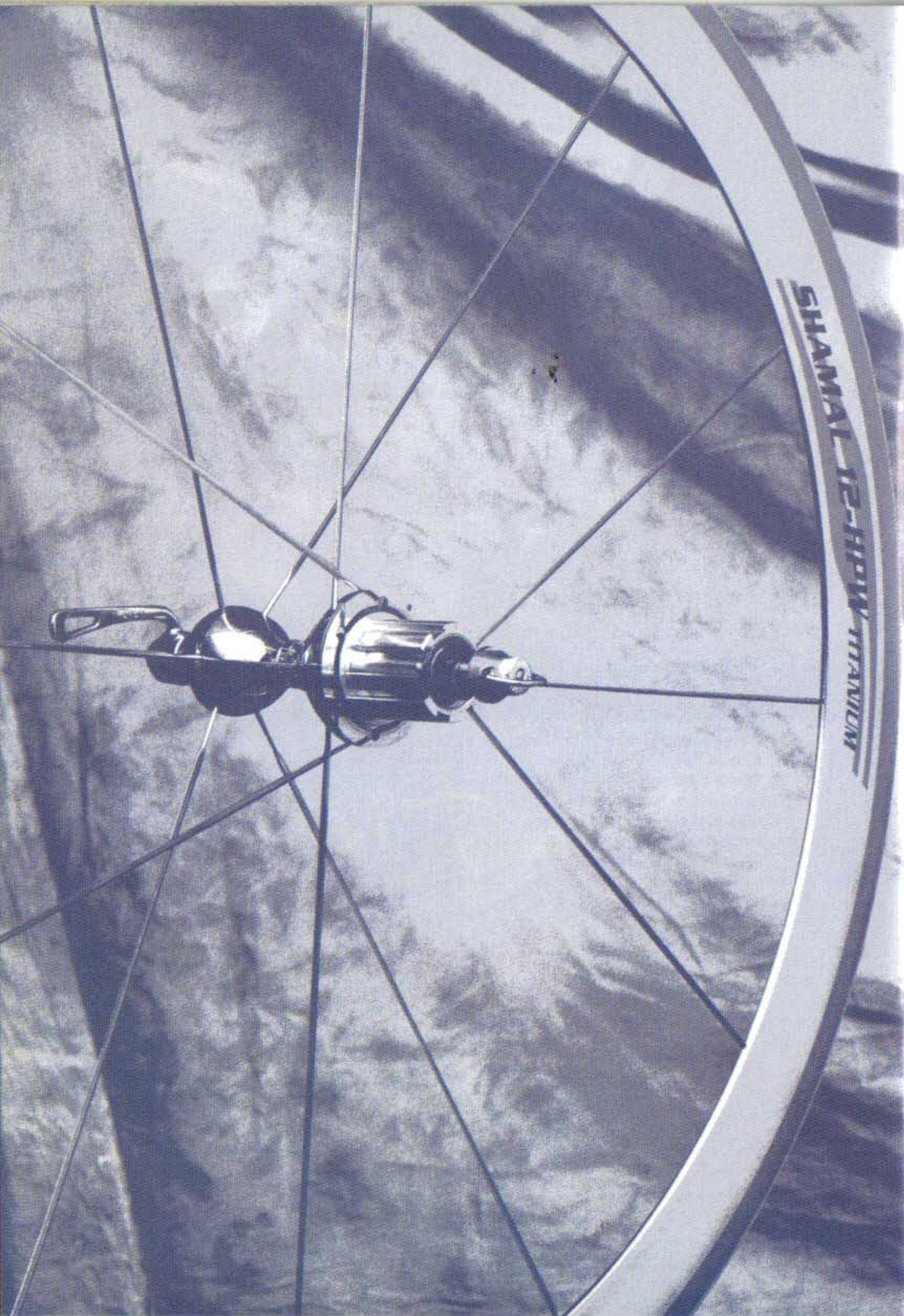

WHEELS

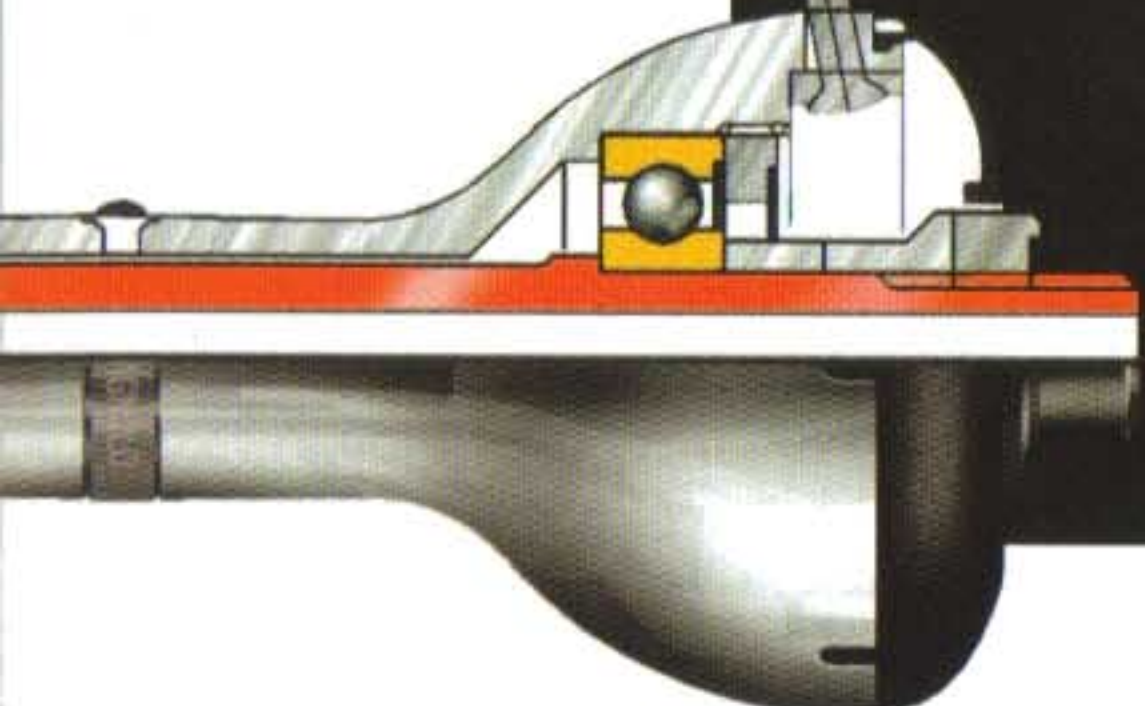
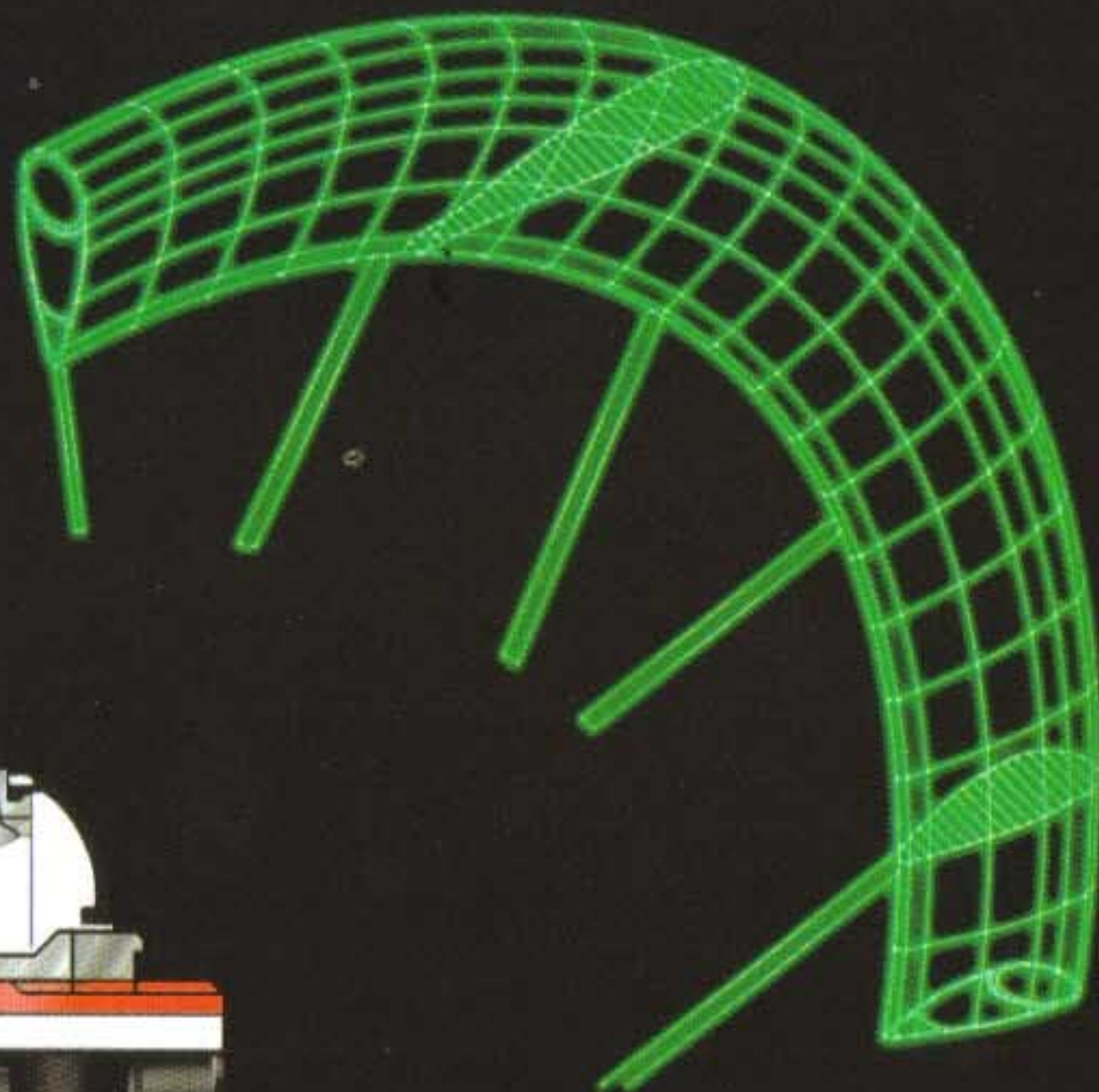

Thanks to their exceptional AERODYNAMICITY, RIGIDITY AND LIGHTNESS, wheels in the CAMPAGNOLO range, the forerunners of a real revolution, are destined to be the leaders in the cycling of the next century.

Many fundamental modifications, to improve further the already extremely high level of performance, have been carried out on the new range, such as the introduction of 9-speed wheels and a substantial reduction in weight, which is always an important energy-saving element for the rider.

Furthermore, in order to bring leading-edge technology within the means of all riders, the range

itself has been extended by the introduction of the new EURUS model, which will be at the low end of the CAMPAGNOLO price range.

YEARS OF RESEARCH IN PURSUIT OF PERFORMANCE IMPROVEMENT

In recent years, the use of wheels with high-walled rims has revolutionised the bike world. These innovations are the result of many years of study, as well as research, in the fields of aerodynamics and production technology.

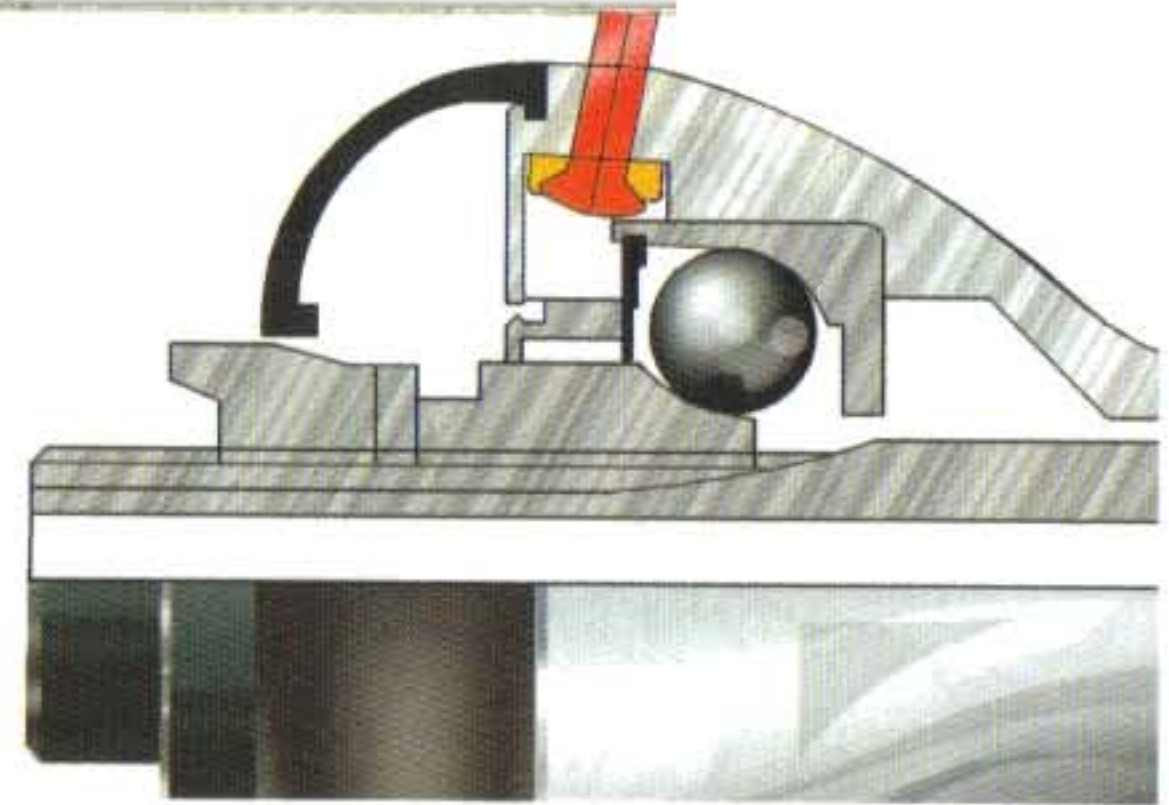

The outcome has been a gratifying recognition by the entire cycling world and an ever-increasing use of this type of wheel in the most varied conditions, even by those who do not compete but who nevertheless entrust their comfort and safety to reliable technology which offers outstanding performance.

WHEELS WITH 9-SPEED HPW HUBS

All wheels with HPW (High Performance Wheel) hubs will be ready for use with the brand-new RECORD and CHORUS gear ensembles with 9-speed freewheels.

In addition, the new SHAMAL 9-speed wheels are equipped, as standard, with super-light front and rear HPW hubs, with titanium spindles and the freewheel cassette body in aluminium. This has led to an even greater reduction in weight which, in the case of the SHAMAL, amounts to 115 grammes.

"HPW" TECHNOLOGY

The design of the HPW hubs, apart from allowing a greater and more balanced dishing of the wheel, enhances the rigidity of the entire wheel structure.

Through the use of HPW hubs it is possible to increase the tension of the straight-headed spokes, which bed into steel backing plates, rather than onto the aluminium of the hub body itself. This increased spoke tension has enabled the number of spokes to be reduced to 12, with a consequent reduction in weight and a further improvement in aerodynamicity.

PERFORMANCE AND SAFETY

All wheels throughout the entire 1997 range have rim walls which

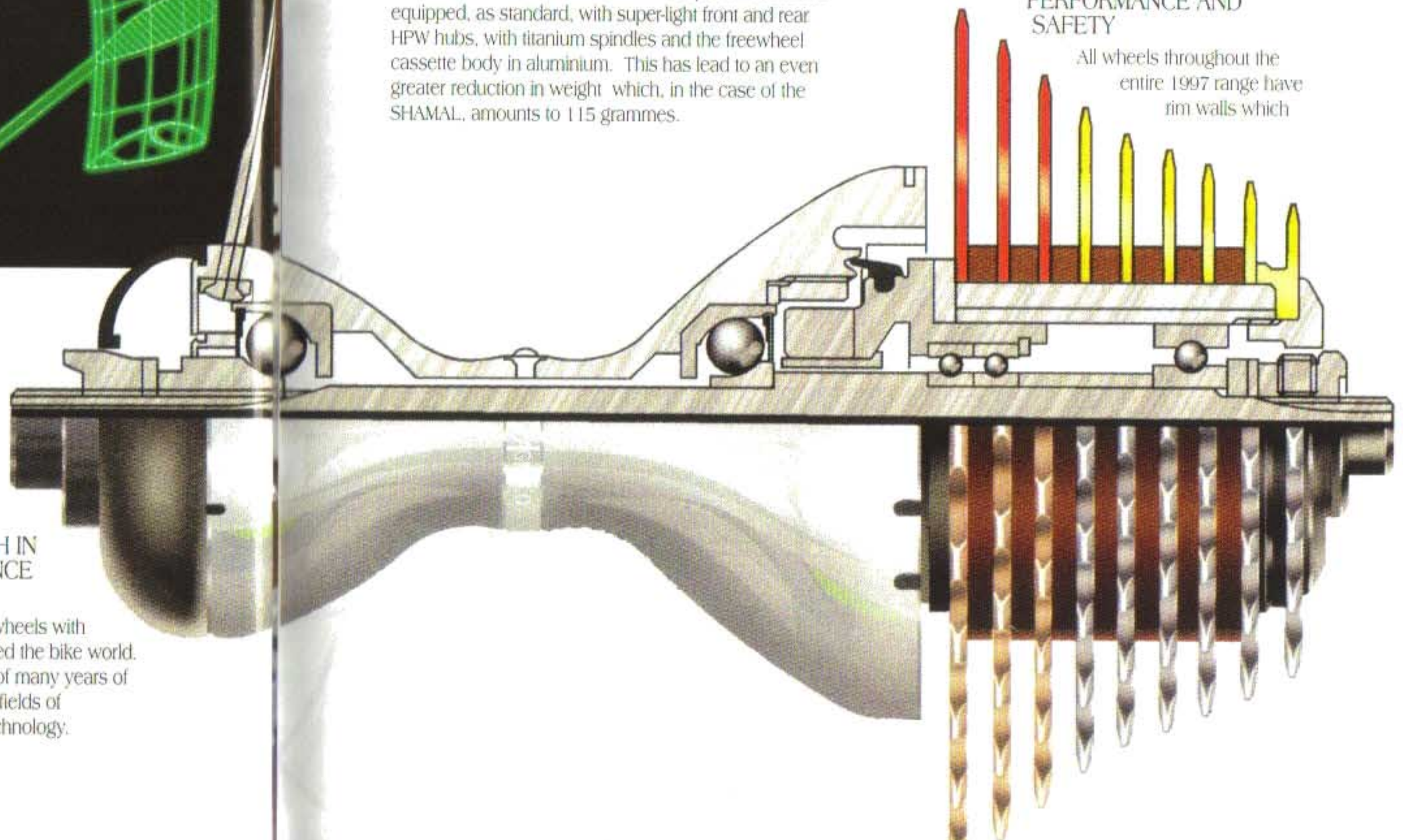



have been treated, depending on the model, with the HPB Control or SWT finishes, previously developed for application to traditional rims.

These finishes guarantee unparalleled braking performance, especially in the wet. CAMPAGNOLO wheels are an extra guarantee for the rider who demands the best.

ZONDA 16 R

Code	Type	Ø	Tyre	Width	O.L.D.	Weight gr
R-ZO306	Front road	28"	Clincher	19	100	899
R-ZO406	Rear road 8 Speed	28"	Clincher	19	100	1.189

EURUS 20

Code	Type	Ø	Tyre	Width	O.L.D.	Weight gr
R-SH107	Front road	28"	Clincher	19	100	920
R-SH108	Rear road 8 Speed	28"	Clincher	19	100	1.211

SHAMAL 12-HPW

Code	Type	Ø	Tyre	Width	O.L.D.	Weight gr
R-SH107	Front road	26"	Tubular	19	100	752
R-SH108	Front road	28"	Tubular	19	100	809
R-SH207	Rear road 9 Speed	26"	Tubular	19	130	975
R-SH208	Rear road 9 Speed	28"	Tubular	19	130	1.032
R-SH304	Front road	28"	Clincher	19	100	864
R-SH404	Rear road 9 Speed	28"	Clincher	19	130	1.087
R-SH405	Rear road 8 Speed	28"	Clincher	19	130	1.182
R-SH106	Front track	28"	Tubular	19	100	920
R-SH204	Rear track	28"	Tubular	19	120	1.010

VENTO 16-HPW

Code	Type	Ø	Tyre	Width	O.L.D.	Weight gr
R-VE306	Front road	26"	Clincher	19	100	833
R-VE307	Front road	28"	Clincher	19	100	914
R-VE406	Rear road 9 Speed	26"	Clincher	19	130	1.088
R-VE408	Rear road 8 Speed	26"	Clincher	19	130	1.131
R-VE407	Rear road 9 Speed	28"	Clincher	19	130	1.169
R-VE409	Rear road 8 Speed	28"	Clincher	19	130	1.212

SCIROCCO 20

Code	Type	Ø	Tyre	Width	O.L.D.	Weight gr
R-SC308	Front road	28"	Clincher	19	100	752
R-SC408	Rear road 8 Speed	28"	Clincher	19	100	809

GHIBLI

Code	Type	Ø	Tyre	Width	O.L.D.	Weight gr
R-GH001	Rear road 7 Speed	28"	Tubular	18	130	1.125
R0071	Front track	26"	Tubular	18	100	820
R0091	Front track	28"	Tubular	18	100	870
R0541	Rear track	28"	Tubular	18	120	960

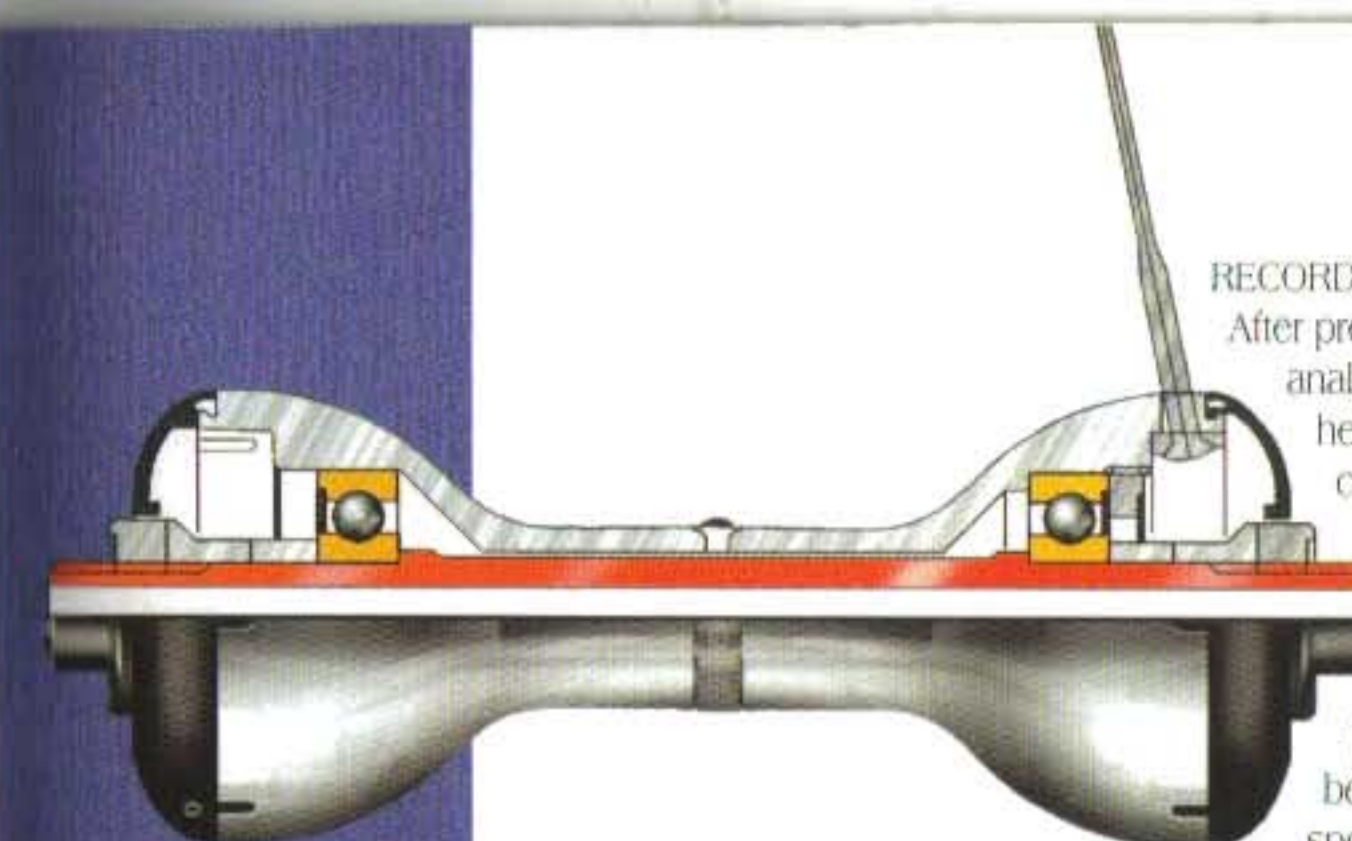

RECORD AERODYNAMICITY
 After precise aerodynamic and mechanical analysis, it has proved possible to reduce the height of the rim wall to 41mm, with a consequent reduction in weight whilst still using only 12 spokes and maintaining the same rigidity which has always been one of its hallmarks. A further notable improvement in aerodynamicity has been achieved through specially designed spoke profiles which help obtain the best air penetration possible.

NEW 9-SPEED HUBS
 By virtue of the use of the new HPW hubs an extra reduction in weight has been achieved, to the tune of 120 grammes per pair of wheels.
 In fact, the SHAMAL 12 HPW wheels with 9-speed cassette freewheels have been assembled with titanium spindles as standard: in particular, the rear hub boasts the internal body in titanium, with the outer splined sprocket body in aluminium.
 SHAMAL wheels are also available in 8-speed versions.

SHAMAL 12-HPW TITANIUM

SHAMAL 12-HPW TITANIUM

SHAMAL 12-HPW TITANIUM

SHAMAL is not only the forerunner of the entire range of CAMPAGNOLO spoked wheels, it also marked the start of a real revolution in the world of wheels generally.
 SHAMAL wheels are extremely versatile, being available in different models for both road and track, for high-pressure tyres and tubulars, for 8 and 9-speed cassette freewheels and in 26" and 28" versions.
 Furthermore, the HPB Control surface finish of the rim walls guarantees superb braking performance, even under difficult conditions, such as in the wet.

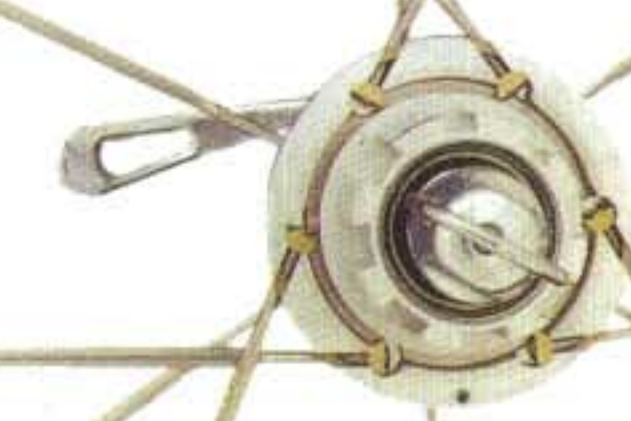



Campagnolo
MADE IN ITALY



Their versatility is enhanced by the fact that they can be used with 8 or 9-speed freewheels.

On the VENTO wheels, too, a great effort has been made to reduce weight even further: the adoption of an aluminium sprocket body on the rear hub has led to a reduction of 60 grammes in weight.

The HPB Control surface finish treatment of the rim walls, developed for the traditional rim range, ensures extremely high braking performance, even in the wet, and provides even greater control, by virtue of the extreme precision in the extrusion of the rim profile and the high quality of the rim jointing.

VENTO 16-HPW

VENTO wheels have been developed with the same design and manufacturing techniques applied to the SHAMAL wheels.

They are aimed at the rider involved in serious competition or, more simply, at those who wish to exploit all the latest advances designed to minimise energy expenditure.

Available in 26" or 28" diameters, they are ideally suited to champion triathletes who are on the look-out for anything that might help them shave even a second off their times.

VENTO 16-HPW



VENTO 16-HPW

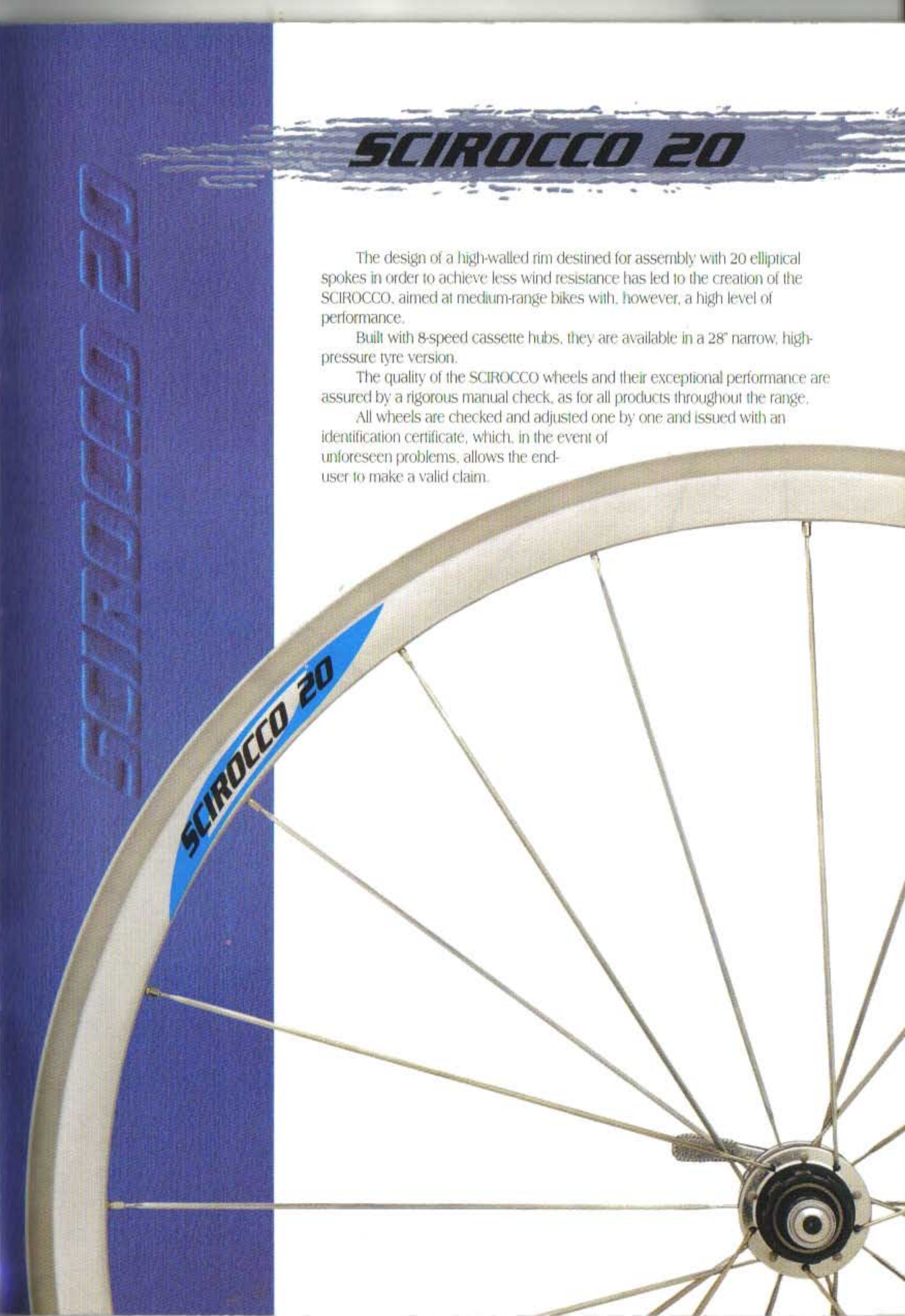

SCIROCCO 20

The design of a high-walled rim destined for assembly with 20 elliptical spokes in order to achieve less wind resistance has led to the creation of the SCIROCCO, aimed at medium-range bikes with, however, a high level of performance.

Built with 8-speed cassette hubs, they are available in a 28" narrow, high-pressure tyre version.

The quality of the SCIROCCO wheels and their exceptional performance are assured by a rigorous manual check, as for all products throughout the range.

All wheels are checked and adjusted one by one and issued with an identification certificate, which, in the event of unforeseen problems, allows the end-user to make a valid claim.

ZONDA 16 R

Designed for the widest possible public, ZONDA wheels are suitable for fitting on all types of sporting bike.

They possess all the intrinsic qualities of aerodynamicity, rigidity and lightness found in top-of-the-range wheels. They are assembled with hubs with 16 elliptical spokes and nipples 'hidden' inside the rim.

Their performance is amongst the best in terms of comfort and safety, a feature of the whole CAMPAGNOLO range.

The increased tension and manual setting of the spokes guarantee continued 'trueness', without the need for further adjustments.

All CAMPAGNOLO wheels come equipped with a valve extender for use when inflating the tyres.

ZONDA 16 R

ZONDA 16 R

SCIROCCO 20

SCIROCCO 20



GHIBLI

GHIBLI wheels are not only for use by professionals but also for all those enthusiasts and top club riders alike who seek record-breaking performance. Used by road riders and also by time trial champions for races on both road and track, the GHIBLI is a disc wheel based on a patented system which calls for the use of KEVLAR.

The exceptional characteristics of this material, by now proven and universally-accepted, have made it possible to produce a disc wheel of a weight similar to its traditional counterparts.

The GHIBLI wheel, unlike typical disc wheels, has optimal vertical elasticity which makes it not only more comfortable but also capable of markedly superior performance.

The road version is equipped with a 7-speed EXA-DRIVE cassette hub.

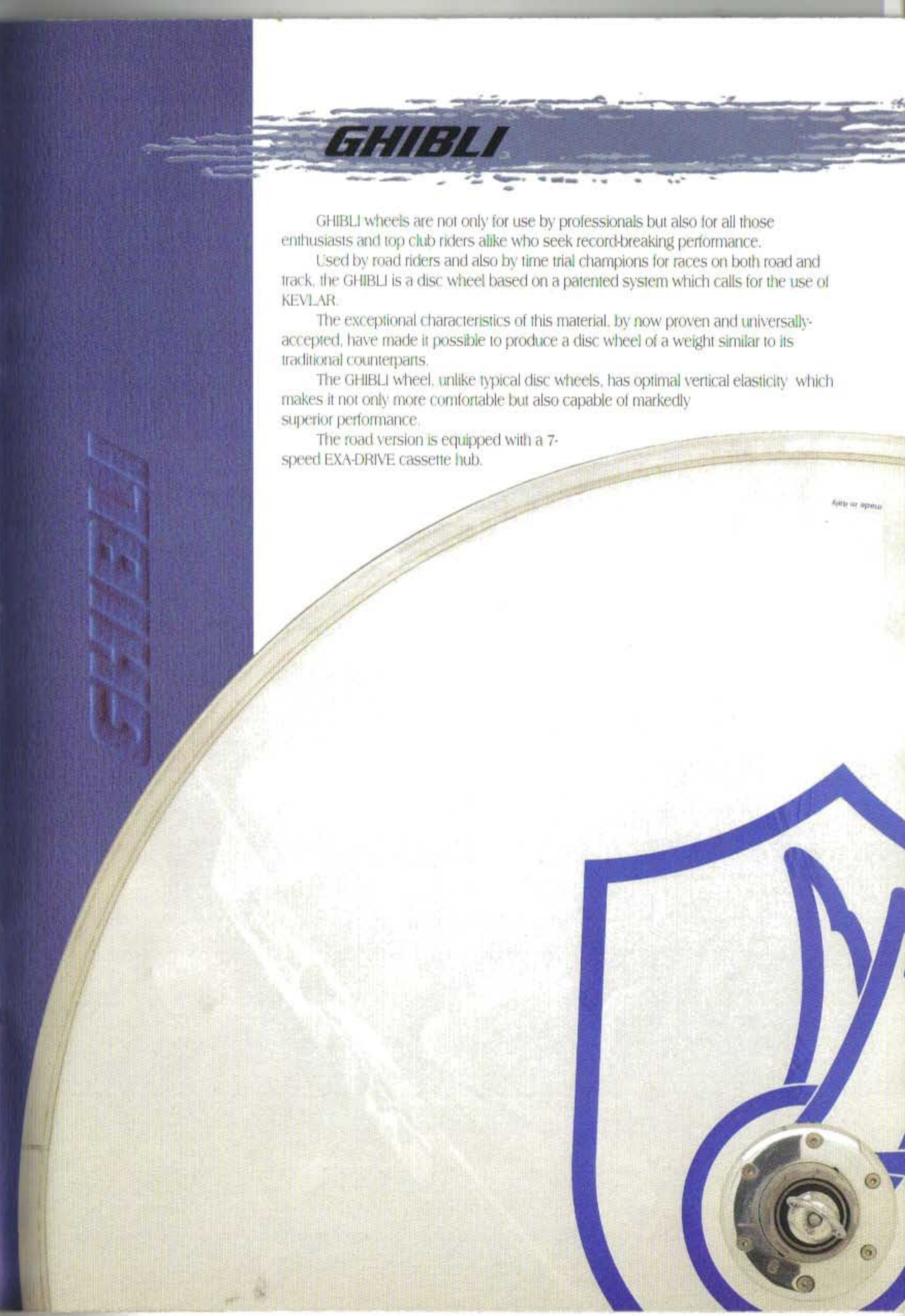

EURUS 20

The EURUS wheels have been specifically built for fitting to the sporting bikes produced by the major bicycle manufacturers and are aimed at a wide public, who wish to spend their free time on a machine which is both safe and up-to-date but who do not seek high-technology equipment.

In harmony with this concept, this new high-profile rim has been designed to satisfy these requirements.

The EURUS wheels are assembled with new 8-speed cassette hubs and standard sealed bearings, which offer an additional guarantee of durability and which require no further lubrication. The brand-new EURUS wheels are also fitted with 20 spokes and are available in a 28" narrow, high-pressure tyre version.

EURUS wheels are the symbol of technology at the service of all cycling enthusiasts.

RIMS



RIMS

A rim for every situation, for every need or for any kind of bicycle. Rims for riding in total safety and in all conditions, in the wet and in the dry.

Long-lasting rims which maintain their aesthetic look. These are the main characteristics which CAMPAGNOLO has sought to improve even more with the introduction of a new range of rims aimed at those enthusiasts who are always on the look-out for products of the highest quality.

SAFETY

Throughout the rim range, be they rims with contoured or pegged joints, new models have been created featuring special surface finishes on the rim walls which dramatically improve braking performance, especially in the wet.

Two technologies have been used:

-The "HPB Control" (High Performance Braking Control) system, applied to rims with contoured joints, which is obtained by micro-grain sandblasting and subsequent finishing of the rim and which increases the friction coefficient of the brake blocks on the rim walls.

**H.P.B.
CONTROL**

-The SWT (Side Wide Treatment) system used for rims with pegged joints, which involves a special precision 'flating' of the rim walls.

Both systems ensure a much faster drying off of the braking surfaces, and a substantial shortening of

SWT

the braking distance, compared with untreated rims, without any increase in the rate of wear of the brake blocks.

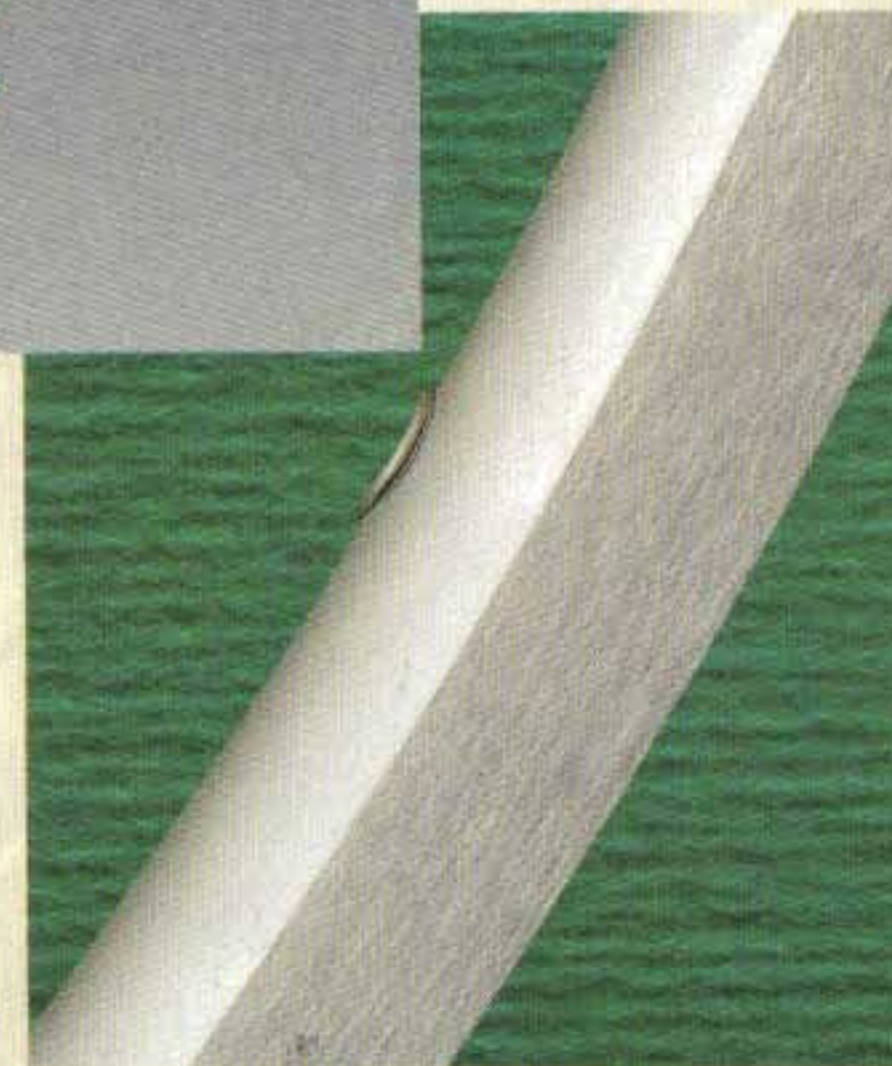

NEW PROFILES

New rim profiles have been designed with all the characteristics of the high-wall models from which they were derived: aerodynamicity, rigidity and durability.

The new ATLANTA 1996 and SYDNEY 2000 (for the road) and the K2 (for mountain bikes) have been designed to exemplify these important qualities, which are essential for high-performance wheels.

In the road range of rims with pegged joints, all models have been produced with new, narrower sections (with a maximum width of 21mm) and are even more suitable for fitting to combative, aggressive-looking race bikes.

DURABILITY

A fundamental feature of a high performance wheel is its long durability, and especially important in this context are its mechanical strength and lasting 'trueness'.

These features are dependent on,

amongst other things, the choice of material used in its construction and the design of its sections.

Another crucial element is its ability to resist oxidation caused by external factors, such as water. Several types of anodised finish have been developed for CAMPAGNOLO rims: on the lower-range models, a new finish, "OXYD", based on the same production methods used on the classic POLISH finish, which it has replaced, offers even greater durability than before.

In addition, all the eyelets used throughout the range are made of stainless steel, a material which, apart from its anti-corrosion properties, particularly facilitates the tensioning of the spokes during the building of the wheel.

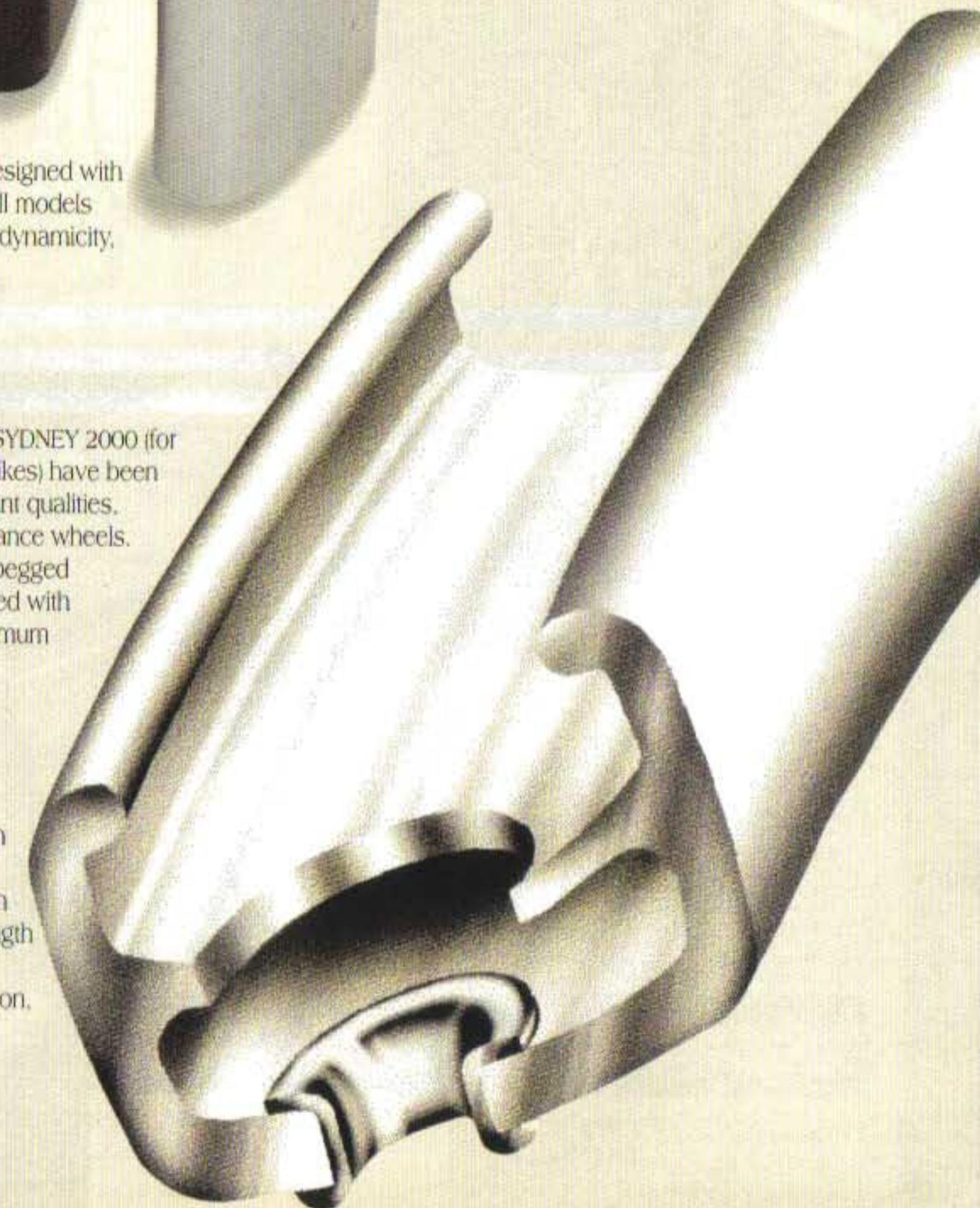

Use:	Road
Type:	Clincher
Ø ETRTO:	622
Spokes:	28 - 32 - 36
Eyelets:	No
Alloy:	6000-T6
Valve Ø:	6.5 mm
Weight:	590 grammes

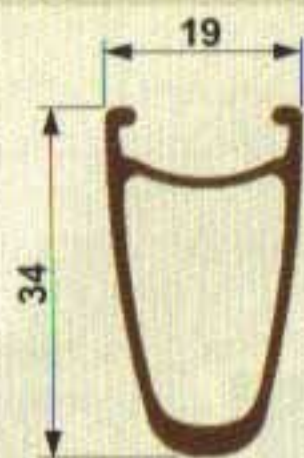

TITANIUM

SILVER

H.P.B.

ATLANTA 1996

Use:	Road
Type:	Clincher
Ø ETRTO:	622
Spokes:	32 - 36
Eyelets:	No
Alloy:	6000-T6
Valve Ø:	6.5 mm
Weight:	553 grammes

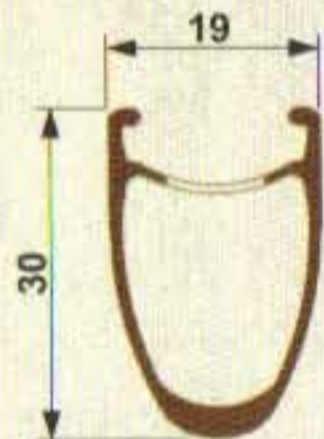

SATIN

SWT

SYDNEY 2000

Use:	Road
Type:	Clincher
Ø ETRTO:	622
Spokes:	32 - 36
Eyelets:	No
Alloy:	6000-T6
Valve Ø:	6.5 mm
Weight:	435 grammes

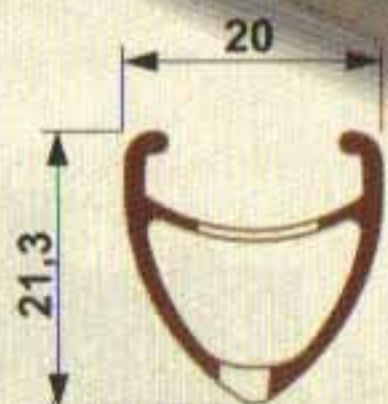

TITANIUM

SATIN

H.P.B.

MOSKVA 80

Use:	Road
Type:	Clincher
Ø ETRTO:	622
Spokes:	32 - 36
Eyelets:	Stainless Steel
Alloy:	6000-T6
Valve Ø:	6.5 mm
Weight:	450 grammes

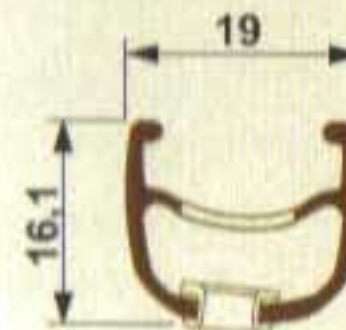

H.P.B.

TOKYO 64

SATIN

BLACK

POLISH

TOKYO 64
ETRTO 13.5x622
6000 SERIES ALLOY T6

ROMA 60
ETRTO 13.5x622
6000 SERIES ALLOY T6

ROMA 60

Use:	Road
Type:	Clincher
Ø ETRTO:	622
Spokes:	32 - 36
Eyelets:	Stainless Steel
Alloy:	6000-T6
Valve Ø:	6.5 mm
Weight:	505 grammes

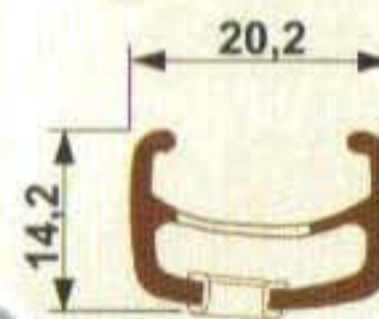

SATIN

BLACK

POLISH

H.P.B.

BERLIN 36
ETRTO 13.5x622
6000 SERIES ALLOY T6

BERLIN 36

Use:	Road
Type:	Clincher
Ø ETRTO:	622
Spokes:	32 - 36
Eyelets:	Stainless Steel
Alloy:	6000-T6
Valve Ø:	6.5 mm
Weight:	535 grammes

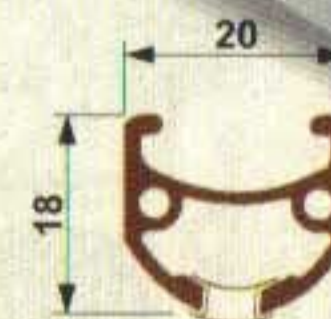

SATIN

BLACK

SWT



Use:	Road
Type:	Clincher
Ø ETRTO:	622
Spokes:	32 - 36
Eyelets:	No
Alloy:	6000-T6
Valve Ø:	6.5 mm
Weight:	492 grammes

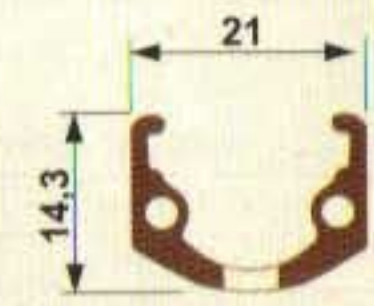

OXYD

LONDON 48

SEUL 88



Use:	Road
Type:	Tubular
Ø ETRTO:	632
Spokes:	28 - 32 - 36
Eyelets:	No
Alloy:	6000-T6
Valve Ø:	6.5 mm
Weight:	395 grammes

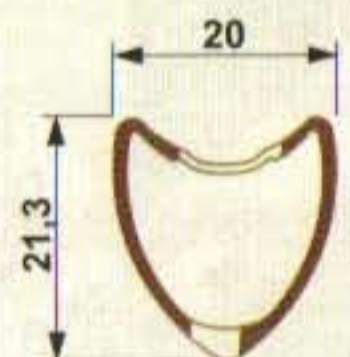

SATIN

H.P.B.

MEXICO 68

Use:	Road
Type:	Clincher
Ø ETRTO:	622
Spokes:	32 - 36
Eyelets:	No
Alloy:	6000-T6
Valve Ø:	6.5 mm
Weight:	485 grammes

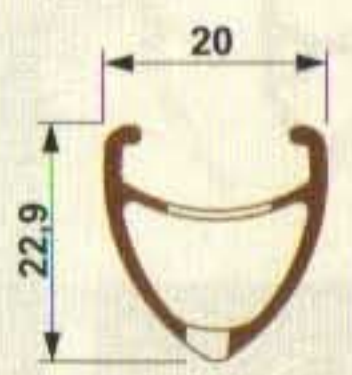

SATIN

BLACK

POLISH

H.P.B.



Use:	Road
Type:	Clincher
Ø ETRTO:	622
Spokes:	32 - 36
Eyelets:	Stainless Steel
Alloy:	6000-T6
Valve Ø:	6.5 mm
Weight:	535 grammes

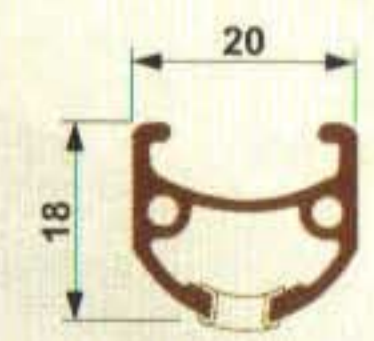

SATIN

OXYD

MELBOURNE 56

AMSTERDAM 28



Use:	Road
Type:	Clincher
Ø ETRTO:	622
Spokes:	32 - 36
Eyelets:	Stainless Steel
Alloy:	6000-T6
Valve Ø:	6.5 mm
Weight:	507 grammes

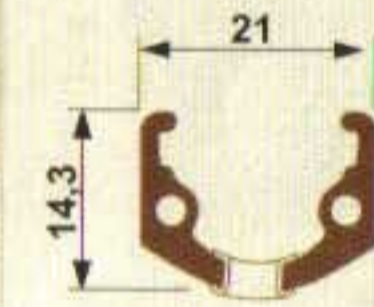

SATIN

SWT

HELSINKI 52

Use:	Road
Type:	Clincher
Ø ETRTO:	622
Spokes:	32 - 36
Eyelets:	Stainless Steel
Alloy:	6000-T6
Valve Ø:	6.5 mm
Weight:	507 grammes

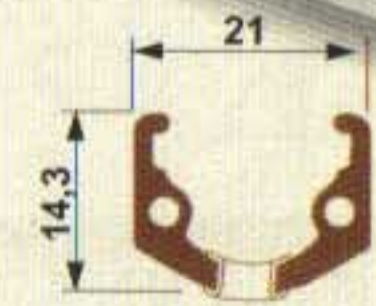

SATIN

OXYD

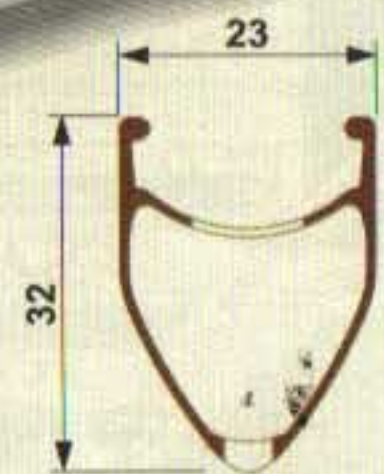

Use:	Off-road
Type:	Tyre
Ø ETRTO:	559
Spokes:	28 - 32 - 36
Eyelets:	No
Alloy:	6000-T6
Valve Ø:	6.5 mm
Weight:	550 grammes

SILVER



Use:	Off-road
Type:	Tyre
Ø ETRTO:	559
Spokes:	32 - 36
Eyelets:	Stainless Steel
Alloy:	6000-T6
Valve Ø:	6.5 mm
Weight:	490 grammes

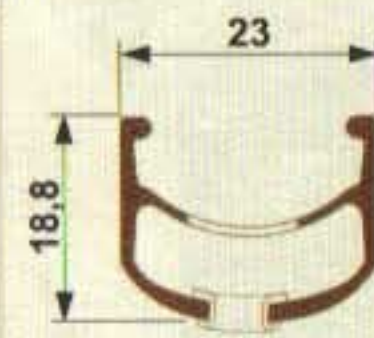

SATIN
BLACK
POLISH



Use:	Off-road
Type:	Tyre
Ø ETRTO:	559
Spokes:	32 - 36
Eyelets:	Stainless Steel
Alloy:	6000-T6
Valve Ø:	6.5 - 8.5 mm
Weight:	535 grammes

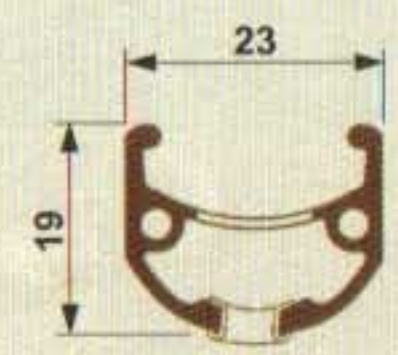

SATIN **BLACK**



Use:	Off-road
Type:	Tyre
Ø ETRTO:	559
Spokes:	32 - 36
Eyelets:	Stainless Steel
Alloy:	6000-T6
Valve Ø:	6.5 - 8.5 mm
Weight:	535 grammes

SATIN

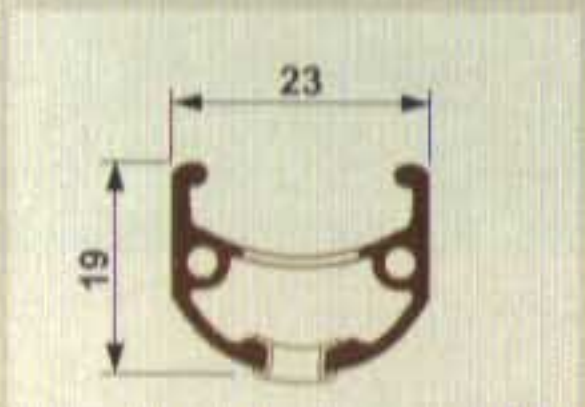

OXYD



Use:	Off-road
Type:	Tyre
Ø ETRTO:	559
Spokes:	32 - 36
Eyelets:	Stainless Steel
Alloy:	6000-T6
Valve Ø:	6.5 - 8.5 mm
Weight:	520 grammes

SATIN

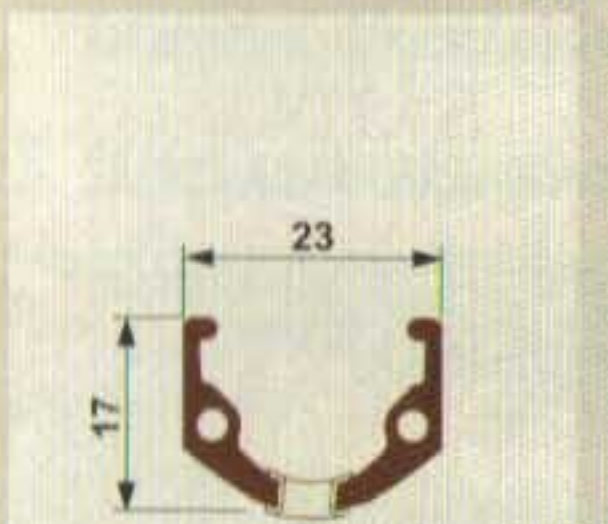

Use:	Off-road
Type:	Tyre
Ø ETRTO:	559
Spokes:	32 - 36
Eyelets:	Stainless Steel
Alloy:	6000-T6
Valve Ø:	6.5 - 8.5 mm
Weight:	520 grammes

SATIN

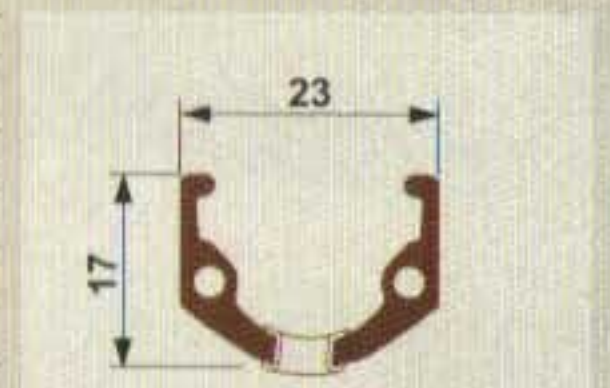

OXYD



Use:	Off-road
Type:	Tyre
Ø ETRTO:	559
Spokes:	32 - 36
Eyelets:	No
Alloy:	6000-T6
Valve Ø:	6.5 - 8.5 mm
Weight:	505 grammes

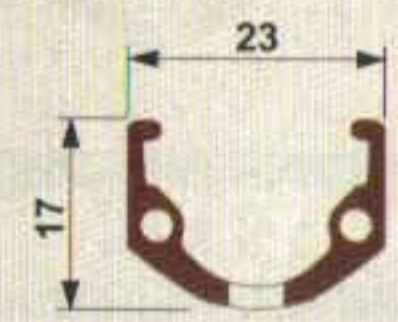

OXYD

Use: Hybrid
 Type: Tyre
 Ø ETRTO: 622
 Spokes: 32 - 36
 Eyelets: Stainless Steel
 Alloy: 6000-T6
 Valve Ø: 6.5 mm
 Weight: 577 grammes

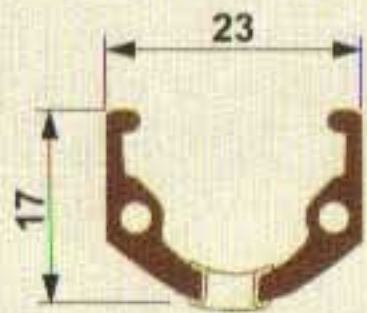

SATIN

SWT

ZIRCON

TOPAZ

Use: Hybrid
 Type: Tyre
 Ø ETRTO: 622
 Spokes: 32 - 36
 Eyelets: Stainless Steel
 Alloy: 6000-T6
 Valve Ø: 6.5 mm
 Weight: 625 grammes

SATIN

SWT

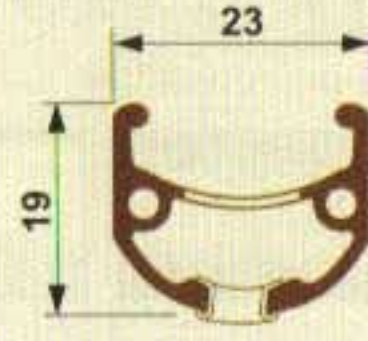

Use: Hybrid
 Type: Tyre
 Ø ETRTO: 622
 Spokes: 32 - 36
 Eyelets: No
 Alloy: 6000-T6
 Valve Ø: 6.5 mm
 Weight: 562 grammes

SATIN

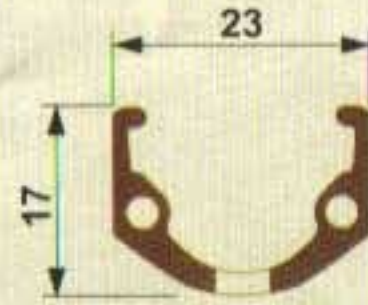

OXYD

TECHNICAL SPECIFICATIONS - GROUPS

	RECORD g Speed	CHORUS g Speed	ATHENA	VELOCE	MIRAGE	AVANTI	RECORD PISTA
REAR DERAILLEUR	max sprocket total capacity brake-on	26 27	26 26	28 26	28 26	28 26	
FRONT DERAILLEUR	clip-on ø 28.6	•	•	•	•	•	
	clip-on ø 32	•	•	•	•	•	
	clip-on ø 35	•	•	•	•	•	
	max. chainring	54	54	54	54	54	
	total capacity	15	15	15	15	15	
CRANKSET	crank lengths (mm)	170-172.5-175	170-172.5-175	170-172.5-175	170-172.5-175	170	165-170
	chainrings	30x52 - 30x53 42x52 - 42x53	30x52 - 30x53 42x52 - 42x53	30x52 - 30x53 42x52 - 42x53	30x52 - 30x53 42x52 - 42x53	30x52 42x52	40-47-48-49 50-51-52
TRIPLE REAR DERAIL.	max sprocket total capacity brake-on		28 37	28 37	28 37	28 37	
	clip-on ø 28.6		•	•	•	•	
TRIPLE FRONT DERAIL.	clip-on ø 32		•	•	•	•	
	clip-on ø 35		•	•	•	•	
TRIPLE CRANKSET	max. chainring total capacity crank lengths (mm) chainrings		52 22 170 - 175 30x40x50 - 30x42x52 32x42x52	52 22 170-175 30x40x50 - 30x42x52 32x42x52	52 22 170-175 30x40x50 - 30x42x52 32x42x52	52 22	
	BT - L 102	•	•	•	•	•	
BOTTOM BRACKET	BC - L 102	•	•	•	•	•	
	IT - L III	•	•	•	•	•	
ERGONOMY	BC - L III	•	•	•	•	•	
	IT - L III	•	•	•	•	•	
BRAKE LEVERS	BC - L III	•	•	•	•	•	
	IT - L III	•	•	•	•	•	
SHIFTING LEVERS	BC - L III	•	•	•	•	•	
	IT - L III	•	•	•	•	•	
BRAKES	BC - L III	•	•	•	•	•	
	IT - L III	•	•	•	•	•	
FRONT HUB	BC - L III	•	•	•	•	•	
	IT - L III	•	•	•	•	•	
REAR HUB	BC - L III	•	•	•	•	•	
	IT - L III	•	•	•	•	•	
SPRICKETS	BC - L III	•	•	•	•	•	
	IT - L III	•	•	•	•	•	
CHAIN	12*3*32	•	•	•	•	•	
	12*3*32	•	•	•	•	•	
HEADSET	BC T2419	•	•	•	•	•	
	HS 100 - ø 1"	•	•	•	•	•	
PEDALS	quick-release	•	•	•	•	•	
	Ø	27 - 27.2	25 - 26.8 3 - 7 - 27.2	25 - 26.8 2 - 7 - 27.2	25 - 26.8 2 - 7 - 27.2	25 - 26.8 2 - 7 - 27.2	27 - 27.2

* 6 steel sprockets - 3 titanium sprockets with L III bottom bracket
 Campagnolo S.r.l. reserves the right to modify the technical specifications without any notice.

G.B.

Campagnolo

CAMPAGNOLO IN THE WORLD:

CAMPAGNOLO FRANCE SARL
B.P. 148 - 42163 Andrezieux
Boulheon Cedex - France
Phone: 77-556305
Fax: 77-556345

SELECT CYCLE COMPONENTS
Cedars Lodge - Cotgrave Road
Owthorpe - Notts NG 12 3GE - England
Phone: 01949-81770
Fax: 001949-81771

CAMPAGNOLO USA INC.
5451h Av. Encinas
Carlsbad-CA 92008-USA
Phone: 619-9310106
Fax: 619-9310991

CAMPAGNOLO IBERICA S.L.
Pintor Jesus Apellaniz, 17
01008 Vitoria - Spain
Phone: 9-45-222504
Fax: 9-45-244007

I.C.C.
PO Box 73-4527
CM Aardenburg - Nederland
Phone: 01177-2820
Fax: 01177-2835

BENGT ULLBERG & CO. AB
Vikdalsgränd, 10A
S - 131 40 Nacka - Sweden
Phone: 00446-8-7183270
Fax: 00446-8-7183271

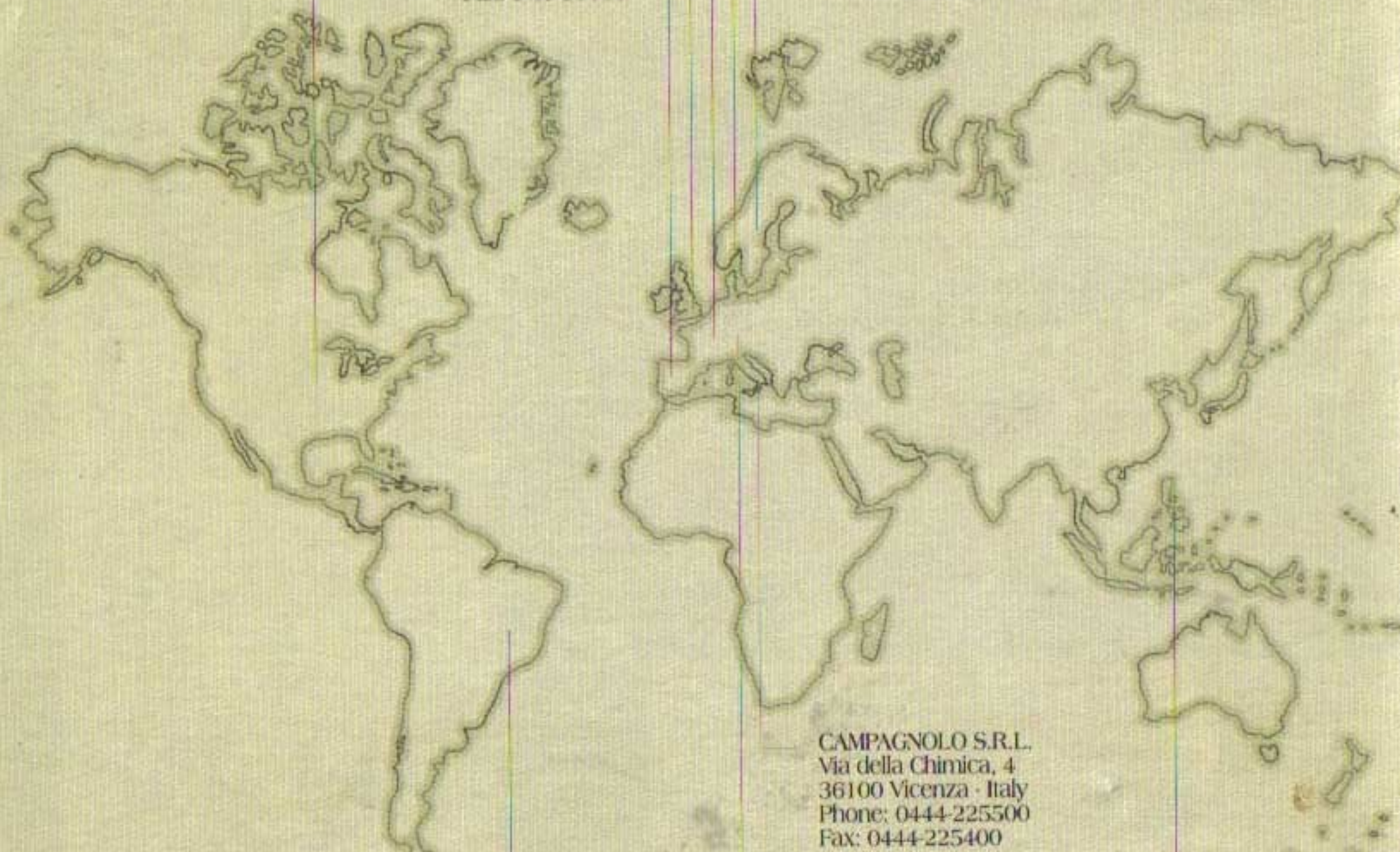

CAMPAGNOLO S.R.L.
Via della Chimica, 4
36100 Vicenza - Italy
Phone: 0444-225500
Fax: 0444-225400

CAMPAGNOLO GMBH
Quettinger Straße, 196
51381 Leverkusen - Germany
Phone: 02171-768254
Fax: 02171-768255

CAMPAGNOLO ASIA
10F-2 - N. 1 Wo-Lung Street
Taipei - TW - ROC
Phone: 2-3778059
Fax: 2-3778062

CAMPAGNOLO
LAT. AMERIC. CML. LTDA.
Rua Monte Alegre 523 Conj. 51
Perdizes - Cep 05014-000
São Paulo/SP - Brazil
Phone: 55-11-629010
Fax: 55-11-629010

SERVICE AND TECHNICAL
INFORMATION:
CENTRAL (ITALY) Phone: 0444-225600
GERMANY Phone: 02171-768208
USA Phone: 619-9310106